

# **Rising Star District Cookbook**



**Rising Star District  
Sam Houston  
Area Council**

## **Rising Dough**

©April 9, 1997

Rising Star District is part of the Sam Houston Area Council of the Boy Scouts of America. The district is comprised of the Cypress-Fairbanks School District in North West Harris County.

Use of these recipes by Gourmet Restaurants is strictly forbidden by the AMA.

## *Bobby Hall*

Boy Scout Roundtable

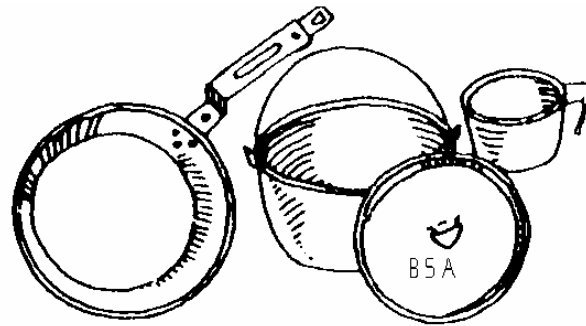

## *Philmont Grace*



*For Food, for rainemt  
For life, for opportunity  
For friendship and  
flellowship  
We thank thee, O Lord*



*"Cooks are not found wandering in the woods. Nor do Scouts fry an egg on the first try. Guide them, teach them, but don't do everything for them."*

District Troops have families from all over. They bring knowledge and experiences from all over the world. And along the way, a few good recipes. Friends and relatives agree that you may have these secret recipes only on one condition. That you add your own and pass on the total to others.

Cooking and eating are an adventure. There is just something about camp cooking that is special. Cooking outdoors requires a different set of rules and equipment. Take time to plan some activities that will include food preparation, whether it is brought in a paper sack or food that will be prepared by the boys. Cooking is a skill and cooking outdoors with charcoal, wood or a buddy burner will take some skill. Take time to talk about what you plan to cook, discuss safety and practice fire building.

**The Plan**

- Number of days and number of scouts in patrol
- Menu planning By Patrol or Troop
- budget \$\$ per scout
- equipment needed Quartermaster
- Review by Assisitant scoutmaster or Troop Guide

**The Execution**

- Shopping By Patrol or Troop
- Practice for new scouts. at a meeting, backyard, at base camp
- packing car camp versus backpacking
- setup **duty roster** fire, water, cooking area
- cooking No seconds, until all are feed
- cleanup inspection?

**Evaluation**

- What worked and what did not food, procedures
- Record results and reciepes for next trip.

**SAFETY AND GOOD COOKING HABITS**

Start out by getting yourself ready to cook.

- \* Protect your clothes from spills by putting on an apron; then wash your hands.
- \* Read the entire recipe carefully.
- \* Organize the bowls, spoons, pans and other equipment that you will need.
- \* Read and know about making fires and fire safety.
- \* Have all the ingredients for the recipe. Measure ingredients accurately. Follow the recipe mixing the ingredients.
- \* While the food is cooking, put things away and clean up your work area.
- \* Stay near your food. If you forget them, the food will cook too long and burn.
- \* Turn pot handles away from the edge so no one will bump the handle and cause pot to spill.

- \* Always use potholders when handling hot pans. Keep all towels, pot holders, clothes and hair away from the flames.
- \* Learn how to use a knife.
- \* Have water or fluid in a pan, when placed on the stove. Even if not lit.
- \* Practice, Practice before trying new recipes in the rain, 20 miles out on the trail.

**Remember** to review the National BSA policy on fuels and the local regulations on fires and fuels. Some Airlines have a problem with transporting empty liquid fuel stoves and fuel bottles. Call ahead and plan if flying to that high adventure camp site.

*Eat hearty and happy camping.*

**General Commandments on trail cookery:** *go light, no fuss, no mess*

- |                                   |  |
|-----------------------------------|--|
| 1. Nutritious                     | <i>What! pop-tarts for supper again?</i>                 |
| 2. Low in weight                  | <i>Less than a 11 yr. old scout.</i>                     |
| 3. Taste Great                    | <i>Scouts sure are great cooks.....</i>                  |
| 4. Cooks fast with no fuss        | <i>Hurry up, the batteries are going...</i>              |
| 5. Meets BSA's handling standards | <i>Packed by a 11 yr. old scout</i>                      |
| 6. Compact                        | <i>Smaller than a 11 yr. old scout</i>                   |
| 7. Cheap                          | <i>No the Money Tree is not in the Forestry Merit...</i> |

Troops from the district have been invited to share their favorite recipes. The recipes were collected over a series of months at district roundtables and compiled with the help of Troop 928.

**Submitted recipes were requested to have the following format.**

- Recipe Name ( something fun to remember )
- Author ( who to blame )
- Troop ###
- Method ( Dutch oven, ONEPOT, Skillet, Foil meal )
- Ingredients ( hopfully with the right amount )
- Cooking Instructions ( We already know the difference between folding and beating )
- Serves # of scouts ( or one hungrey scoutmaster )

Highly recommended reading for Parents, Leaders, and grommet Scout cooks and eaters:

**Camp Cookery for Small Groups, Arthur J. Walrath, ed., 1967, BSA**

Eating well is not just part of the fun of camping. It is important to eat well to replace the energy used in the hiking and activities that busy scouts are prone to do. High fluid intake and high caloric intake are needed. Seasonal changes may demand over 3,000 calories per day. The food pyramid is a guide for meal planning. The Pyramid can change with camping. The high calorie diet of campers use more fats during colder weather. Try to take the bulk of the food from the carbohydrate group.

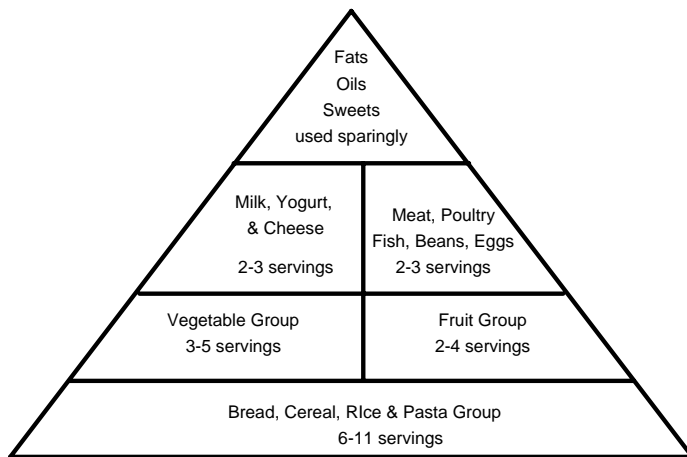

We have tried not to duplicate the many books available on camp cooking (see additional reading list). We have tried to place our own stamp on the type of cooking that our troops like, but do not limit yourself to the recipes, invent your own. The following recipes are for the adventuresome who would like to try different things. Great, but try them at home first, not 20 miles out on the trail.

Take special note of any dietary needs of the scouts and adults. Allergies to foods are common. Don't forget the duty roster. It will save time on determination of who's turn to do what.

<b>When</b>	<b>Water</b>	<b>Fire / Stoves / Cook</b>	<b>Clean Up</b>	<b>Food Bags</b>

## Menu Planning

### Larry Hoffman, Troop 483

One of the most important things we do to prepare for a campout is to plan what we will eat. You should be able to make anything outdoors that you can make at home. The important thing to remember is that the meals need to be cooked, they need to be balanced, and they need to be good food that you like. The following is a list of suggested menus that you can use to assist you in your menu planning.

Breakfast -Breakfast can be the best meal of the day if you take time to plan and prepare it. Always serve a main dish, fruit (fresh or dried), and juice. Poptarts, granola bars, and dried cereal are not suitable for Boy Scout breakfast.

- *Breakfast Burritos* - Use flour tortillas, scrambled eggs with sausage and cheese. You can also add chopped onions and green peppers. Serve with hot sauce.
- *Instant oatmeal or grits* - This is a good meal when you are backpacking or for Sunday mornings when you are getting ready to break camp and go home.
- *Biscuits and Gravy* - Use the canned biscuits and instant gravy mix. You can cook about 12 biscuits in a #10 Dutch oven. The instant gravy mix uses only water to make. Fry sausage patties or bacon to eat with the biscuits.
- *Pancakes* - Use instant batter and make on the griddle from the chuck box.
- *Cinnamon rolls* - Use the canned cinnamon rolls and bake them in a Dutch oven, box oven, or pie pan oven. These are a good meal with fruit and juice.

Lunch - As a rule lunch should be a light meal that can be prepared with the minimum of utensils and effort. Always plan to have some type of bread products, vegetables, fruit, and a protein. Plan to make some type of Kool-aid or punch. Canned sodas, boxed juices, and bottled drinks are not allowed at Troop campouts.

*Soup and sandwiches* - The best type of soups to make are the instant noodle soups like Ramen Noodles or Lipton Chicken Noodle soups. They are easy to prepare and they taste good. You can add canned chicken to them if you like. Keep the sandwiches simple. Grilled cheese, peanut butter and jelly, or tuna salad are good suggestions. Plan to serve carrot sticks or a green salad.

- *Burritos* - Burritos are very simple and very good. The beans can be heated right in the can (if you are careful). Wrap them up with grated cheese and a little hot sauce. Serve with vegetable sticks dipped in salad dressing and juice.

- *Pizza* - Pizza is a favorite of just about everyone. The best way to make pizza is in the Dutch oven or pie pan oven. Use canned biscuits or Boboli pizza shells for the crust, bottled Pizza sauce, mozzarella cheese, and your choice of toppings. Serve with carrot sticks, fruit, and juice.
- *Tacos* - Make tacos or taco salad using hamburger meat, cheese, lettuce, tomatoes, and taco sauce.

*Dinner* - Dinner needs to be the meal that you make the fanciest meal of the day. At dinner you really want to show off the cooking skills of you Patrol. You should serve a meat, vegetable, bread or pasta, fruit, and juice.

- *Foil Packs or Silver Turtles* - These are the easiest and most foolproof of the dinner menus. You can make you meat and vegetables at the same time. You can be very creative with Silver Turtles. Use a variety of meats, such as hamburger, sausage (links or packaged), chicken, pork, ground turkey, or fish. Any type of vegetable can be used. Traditionally silver turtles are made with sliced potatoes, carrots, onions, and mixed vegetables (canned). Season them with any type of appropriate spice, They are very good with a little BBQ or A-1 sauce poured in them. For dessert you can wrap up an apple that has been cored and filled with brown sugar or redhots and cook it with the foil pack. Be creative since you won't have to spend a lot of time cleaning up.
- *Spaghetti* - Spaghetti is a good dinner meal. There is only one catch . . . you cannot use sauce from the jar. If you are going to make spaghetti you must make your own sauce from scratch. It is very easy to do with browned hamburger or Italian sausage, Italian spices, and tomato sauce. You can spice it up with onions and garlic. Serve it with a green salad and garlic bread. Make garlic bread in the box oven or Dutch oven.
- *Stew or soup* - During cold weather a nice stew or soup is very good and easy to make in Dutch oven. It is best with beef cubes, potatoes, assorted vegetables all cooked together until they are done. Serve with bread and juice.
- *Fajitas* - Chicken or beef fajita are simple to make and even better to eat. They can be made over charcoal on a grill or in a skillet or griddle. Be sure to make some sautéed onions with them. Serve with tortillas, green salad, grated cheese, hot sauce, and juice.

*Desserts* - The favorite meal of the day has got to be dessert. Keep in mind that anything you can make at home in your stove or oven you can make on a campout. You can bake cookies, pies, cakes, cobblers, turnovers in a Dutch oven or box oven You can make pudding or pop popcorn. Plan to make at least one dessert on each campout. The most popular is Dutch oven cobbler, but don't limit yourself.

Drinks - Plan to drink juice or Kool-aid on every campout. Orange juice (Tang) is great for breakfast and Kool-aid will be your drink of choice for all other meals. Have packets of Hot Chocolate in the Patrol gear for cool evenings and mornings. Remember, no sodas, boxed drinks or canned drinks. Less to dispose of.

Snacks - Plan to have snacks for the Patrol. Do not bring candy or junk food unless you bring enough for the entire group. Good snacks for campout include Gorp, trail mix, jerky, and chewing gum.

Vegetables - It is important that you eat some vegetable with lunch and dinner. If possible, try to cook the vegetable with the meat. Carrot sticks are always easy and good.

Fruit - Fruit should be planned for every meal and snacks. Oranges, apples, bananas, and raisins are the most common. Baked apples make a great dessert.

Meat - Try to have a meat dish for every meal. Remember that fresh meat can spoil quickly in the Texas heat so freeze it before you bring it. Use canned meats whenever possible (canned tuna, chicken, or SPAM). They do not spoil and if prepared properly they are very good.

Breads and Pasta - Breads and pasta are where we get the energy we need to keep going all day. Plain white bread is okay but it can be smashed very easily. If possible, substitute tortillas or pita bread. English muffins are good also.

### **ScoutMaster Rule #3**

**“Take seconds only after the rest have finished firsts”**

*Fred Wantsommor*

### **Scoutmaster Rule #47:**

**"No Boy Scout ever starved to death on a weekend campout."**

**-- Roger Morris, Scouter**

## Camper's measurements without utensils

1 Open Fistful	=	1/2 cup
Five-Finger Pinch	=	1 Tablespoon
Four-Finger Pinch	=	1 Teaspoon
One-Finger Pinch(with thumb)	=	1/8 Teaspoon
One-Finger Gob of shortening	=	1 Tablespoon
Palm of hand (center)	=	1 Tablespoon

### Fluid Standard Measures

3 Teaspoons	=	1 Tablespoon	=	1/2 oz	=	29.57 milliliters
16 Tablespoons	=	1 Cup	=	8 oz	=	0.236 liters
2 Cups	=	1 Pint	=	16 oz	=	0.473 liters
2 Pints	=	1 Quart	=	32 oz	=	0.946 liters
4 Quarts	=	1 Gallon	=	128 oz	=	3.785 liters

### SUBSTITUTIONS & EQUIVALENTS

1 lb. butter / shortening	=	2 cup
4 oz. cheddar cheese	=	1 cup grated
1/2 pt. whipping cream	=	1 cup ( 2 c. whipped)
8 oz. sour cream	=	1 cup
1 lb. flour	=	app. 3 1/2 cup
1 cup marshmallows	=	11 large or 110 miniature
1 lb. brown sugar	=	2 1/4 cup (packed)
1 lb. granulated sugar	=	2 1/4 cup
1 cup milk	=	1/2 cup evaporated milk + 1/2 cup water -or-
	=	1 cup reconstituted dry milk + 2 tbs. butter
1 cup buttermilk	=	1 cup milk + 1 tbs. vinegar
	=	3/4 cup milk + 1/4 cup butter + 1 1/2 tsp. corn starch
1 stick butter	=	1/4 lb. or 1/2 cup or 8 tbs.
1 lb. loaf bread	=	about 17 slices
1 1/2 tsp cornstarch	=	1 tbs all purpose flour
1 cup Honey	=	1 1/4c sugar + 1/4c water or other liquid

Emergency should be the only excuse for substituting ingredients in a recipe.

**Menu Sheet**

for \_\_\_\_\_ scouts

date: \_\_\_\_\_

<b>Breakfast</b>	<b>amount</b>	<b>equipment</b>	<b>cost \$</b>
drink			
meal			

<b>Lunch</b>	<b>amount</b>	<b>equipment</b>	<b>cost \$</b>
drink			
meal			
fruit			

<b>Dinner</b>	<b>amount</b>	<b>equipment</b>	<b>cost \$</b>
drink			
meal			
desert			
fruit			

## Sample Meal Evaluation Sheet

Information provided by Scott Dillard, Scouter

Here's an evaluation sheet that the Patrol Leaders have in their Troop Leaders Notebooks and use from time to time to evaluate how their meal process is (or is not) going:

- \_\_\_ Was the food good?
- \_\_\_ Was there enough food for everyone?
- \_\_\_ Was there not too much food wasted?
- \_\_\_ Did everyone get his fair share of food?
- \_\_\_ Was the duty roster posted and used?
- \_\_\_ Did everyone do his job without complaining?
- \_\_\_ Did everyone offer to help others with their jobs when they could?
- \_\_\_ Was it a well-balanced meal?
- \_\_\_ Did you say grace before the meal?
- \_\_\_ Did you give your patrol yell?
- \_\_\_ Is the patrol area clean after the meal?
  
- \_\_\_ Was there enough water for the meal?
- \_\_\_ Was there enough water to put out the fire?
- \_\_\_ Was the fire prepared on time?
- \_\_\_ Did you use a fire starter?
- \_\_\_ Was it a "legal" fire starter?
- \_\_\_ Was there a ready means for putting out the fire in case it got out of control?
- \_\_\_ Was there enough firewood for the entire meal (without having to go get more)?
- \_\_\_ Was the fire kept going through the meal until the KPs were through?
- \_\_\_ Was the fire properly extinguished when KPs were done?
- \_\_\_ Was the fire always attended (never left alone)?
- \_\_\_ Was the fire the right size for the job?
- \_\_\_ Did anyone who was not busy offer to help the fire/water crew?
  
- \_\_\_ Was the meal prepared on time?
- \_\_\_ Was the food warm when it was served?
- \_\_\_ Did the cooks wash their hands before they started?
- \_\_\_ Did the cooks have the food ingredient list for this meal?
- \_\_\_ Did the cooks have all the food ingredients they needed?
- \_\_\_ Did the cooks know how to prepare the meal?
- \_\_\_ Were the cooks ready to cook when the fire was ready?
- \_\_\_ Did you have the right hardware to do the job (for example, pots, pans, utensils, can opener, gloves, HPTs)?
- \_\_\_ Were missing hardware items written down by the Patrol Quartermaster so that you will have them next time?
- \_\_\_ Was the fire right for cooking (not too cold or too hot)?
- \_\_\_ Were the outside of cooking pots soaped before they went on the fire?
- \_\_\_ Did the cooks serve the food?
- \_\_\_ Was the entire meal ready and served at the same time?
- \_\_\_ Did the cooks have enough help?
- \_\_\_ Was a little water put in emptied pots to keep food from hardening?
- \_\_\_ Did the cooks make sure the kitchen area was clean when the meal was done?
- \_\_\_ Did anyone who was not busy offer to help the cooks?
  
- \_\_\_ Was KP completed on time?
- \_\_\_ Was a sump hole used for the wash water?
- \_\_\_ Was the sump hole located in a proper place?

- Was the wash water hot when the patrol finished eating?
- Was there enough fire to heat the water quickly?
- Did everyone AP his own personal gear?
- Did the KPs AP the kitchen gear?
- Was everything AP'd before it was washed?
- Was the gear washed and rinsed properly?
- Was the Dutch oven properly cared for?
- Was the sump hole filled in if this was the last meal of the day?
- Did anyone who was not busy offer to help the KPs?

KP = Kitchen Police

AP = area police

## ScoutMaster Rule #4

**“Scouts should learn to find water, start a fire, and make coffee for the Scoutmaster.”**

*A. J. Anonymous*

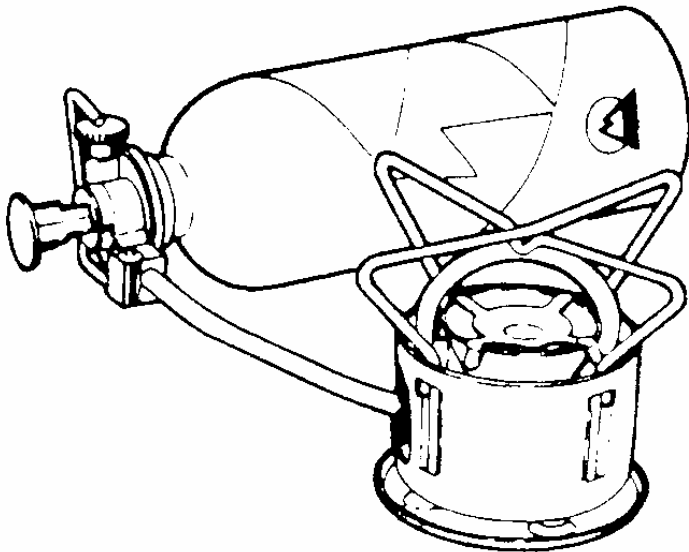

**Kitchen accessories mostly shared between scouts as patrol gear**

water proof matches:	with their safety striker box
Match safe:	water proof with strike anywhere wooden matches
camp stove lighter:	Again with the fire.
fire starter, fire ribbon, primer:	for starting cranky stoves
tinder:	for starting cranky fires
fuel bottles / containers:	for fuel only, not for anything else.
funnel:	for pouring fuel into itty bitty stove tank openings
pouring cap:	for pouring fuel into itty bitty stove tank openings
pliers:	for fixing cranky stoves
bandanna:	for holding hot pots when you forget your gloves
Pot grippers:	for holding hot, hot pots when you forget bandanna
grid /grate:	for holding pots higher over the burner or coals.
splatter shield / wind shield:	the wind is always blowing
2'x3' plastic 6 mil sheet:	Clean area to put things down on and catch spills
nylon spatula:	for frying on Non-Stick surfaces
whisk:	for mixing batters and puddings
aluminum foil:	several sheets for cooking, wind screens
handy-wipes:	for drying dishes, reusable
scouring pad / sponge:	clean up
pine cone	for when you forgot the scouring pad
Soap:	small bottle biodegradable dish soap, in a zip bag.
trash bags:	several for bag in bags
"spice rack":	collection of spices in small bottles or film containers, salt, pepper, garlic powder, onion flakes, bell pepper flakes, cinnamon, Italian seasoning, etc.
Butter Buds:	Seasonings, not for frying
Cooking oil:	In a small plastic bottle and in another zip bag
Small can opener:	better than the one on your knife.
Spring Steel Handle:	Hand made for when you forgot the pot grippers, pliers, and bandanna
ZIP bags	for all kinds of things, wet and dry, all sizes.

## Special Cooking Terms

**Blanche:** To cook quickly in boiling water. Vegetables are blanched, then plunged into ice water to set their color or to make them easier to peel.

*Boy Scout Definition: Add boiling water to instant vegetable soup mix.*

**Cream:** To beat air into butter or shortening. Usually in combination with sugar. A common baking mistake is not creaming thoroughly. It can take up to 10 minutes to make butter really fluffy.

*Boy Scout Definition: To beat up the butter, till it yells uncle.*

**Deglaze:** To add liquid - usually wine, stock or juice - quickly to a hot pan. The cooking residue in the pan is loosened, adding flavor. The liquid is then boiled (cooked down) for a quick sauce.

*Boy Scout Definition: To add boiling water to clean the pot.*

**Fold:** To mix one ingredient very gently with another, such as adding beaten egg whites to a batter without deflating them. Not to be confused with stirring, which is more vigorous. Fold with a rubber spatula, scooping under the main ingredient and folding it over the added ingredient.

*Boy Scout Definition: Bend a tortilla in half*

**Peaks:** Sufficiently beaten whipped cream or egg whites will stand up in peaks. To test, lift the beater or whip: Soft peaks will point up, then fold over. Stiff peaks will stick straight up.

*Boy Scout Definition: Climb every Mountain, Ford every Stream*

**Poach:** To cook an ingredient, usually fish, boneless chicken, or fruit, in a gently simmering liquid, usually water flavored with herbs. Some fruit juices can make flavorful poaching liquids too.

*Boy Scout Definition: No. Don't shoot the King's deer.*

**Reduce:** To boil a liquid rapidly until it partially evaporates. Reducing concentrates flavor of stocks for sauces.

*Boy Scout Definition: Smaller and Smaller*

**Zest:** The outer, colored portion of citrus peel. Doesn't include any of the white part of the peel, which is bitter. To remove the zest, use the small holes of a grater and rub very gently, or use a zester or a vegetable peeler to peel off longer strips. If you get any of the white part on a strip gently scrape it off with a knife point.

*Boy Scout Definition: Eat them up.*

## INTERNET SITES:

The Backcountry Home Page

<http://io.datasys.swri.edu/Overview.html>

<http://io.datasys.swri.edu/Recipes.html>

Backpacker Magazines Basecamp page

<http://www.bpbasecamp.com/>

G.O.R.P Great Outdoor Rec. Page

<http://www.gorp.com/default.htm>

<http://www.gorp.com/gorp/food/main.htm>

Jim Speirs' Scouting Page

<http://www.geostat.com/scouts/index.htm>

MacScouter page

<http://www.macscouter.com/Cooking/>

The NetWoods Virtual Campsite

<http://www.isd.net/stobin/>

<http://www.isd.net/stobin/scouting.html>

U.S. Scouting Service Project

<http://www.scouter.com/sl/Reference/Cooking/>

<ftp://ftp1.scouter.com/usscouts/ScoutDocuments/Cooking/>

## Water Purity

Water Purity in the campsite should not be taken for granted. Dirty hands can contaminate food as easily as bad water. Wash hands frequently, before food preparation and before eating, and after toilet use. Don't wash hands and face with contaminated water. Brush teeth only with treated water. There are 4 main methods of insuring safe water.

1. Bring enough along for the trip. This may be a problem on long trips. Water weighs 8 lb./gal.
2. A Filter/purifier and be used. The filter can clog up and need replacing. 1 to 1.5 pounds
3. Chemical treatment with Iodine tablets or Polar Pure. Water needs to warm to 60 F to kill Giardia Cysts, and will turn mashed potatoes purple. Chlorine bleach can also be used (5%), but may make your blue jeans whiter than white. Halazone and Calcium hypochlorite crystals have a short shelf life after opening.
4. Boiling the water. 150 F will do, but who brings a thermometer. Hard to make cold drinks with and uses extra fuel.

## Breakfast Anyone?

*Aluminum Eggs*

*Ed Bailey*

**FOIL**

**1 Sausage Patty**      **1 handful Hash Brown Potatoes**  
**1 dash water**      **1 Egg**      **salt, pepper, spices**  
 Wrapped in double foil pack and placed on coals for  
 10-15 min. If it burns, cut down the time.

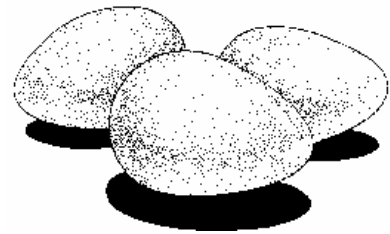

*Mineshaft Pig*

*Ed Bailey*

**FOIL**

**1 potato**      **1 sausage link**      **aluminum foil**  
 Core a tunnel in a potato with an apple corer, then stuff the tunnel with a sausage link. Wrap in foil  
 and bake on coals, or in oven for about 45 min.

*The Better Bator - Wanza Batter*

*Lou Bator*

*T928*

**Skillet**

**2 cups flour**      **4 tsp. baking powder**      **1 stick melted margarine**  
**1 cup buttermilk**      **2 eggs (minus shells)**  
 Mix above ingredients then add regular Homogenized milk 'till batter is right consistency. One half  
 measures of above works as well. GRRREAT Pancakes !!!!

*Worm in the Apple*

*Canadian Scouts*

**FOIL**

**1 Apple**      **1 sausage link**      **aluminum foil**  
 Core an apple, stuff with sausage link, wrap in foil, cook until soft (~40 min.) Canadian Scouts..

*Ants in the Oatmeal*

*Dick Ross*

*T928*

**Onepot**

Regular oatmeal (not instant) with brown sugar, raisins & nuts, canned fruit

*Cream of Freebies*

*Michael Vesely*

*T928*

**Onepot**

**1/2 cup boiling water,**      **1/2 cup Cream of Wheat**      **and freebies**  
 Add freebies from the breakfast menu's of those fine restaurants: Grape Jelly and Strawberry Jam  
 from MacDonal'd's, Honey from KFC or Burger King, Sugar packets...

*Spamble Eggs*

*Michael Vesely T928*

*Skillet*

**1 can (7 oz) SPAM**                      **12 eggs**                      **1/2 cup Sanalac instant milk**  
**2 Tbl. dried onions**                      **2 Tbl. dried green pepper**

Dice the SPAM and fry in large pan. Crack and stir the eggs and milk with a whisk in a large bowl. Leave the egg shells out. Hydrate the dried onion and peppers, then add to the SPAM. Fold the eggs over the SPAM and spamble them. Serve to 6 scouts

*Kansas Fly Pie*

*Ed Bailey T911*

*Skillet*

**1 lb. cornmeal**                      **2 qt. water**                      **1 tsp. salt**  
**1/4 - 1/2 cup raisins**                      **beaten eggs**                      **syrup, honey, or jam**

You may want to start this at home..

Put 2 quarts of water into a pot, make sure the pot can hold 4 qt. Add 1 teaspoon salt; bring to boil; pour cornmeal into the water a handful at a time (about 1 lb.) stirring constantly until the mush gets thick. Cover and simmer slowly for 20 min. Stirring often; add raisins; mix well; poor into greased bread pans (2) and let cool until congealed. Slice loaf into 1/2 inch thick slices; dip in beaten eggs; then fry, hot and browned. Serve with syrup, honey, or jam.

*Sam's Bullfighter Breakfast*

*Ed Bailey T911*

*Skillet*

**1 lb. cornmeal**                      **2 qt. water**                      **syrup, honey, or jam**  
**1 tsp. salt**                      **1 pound of cooked, crumbled sausage**  
**beaten eggs**                      **1 small can of diced chilies** (mild or hot)

Same as the Kansas Fly Pie, however, you skip the raisins. Instead, add 1 pound of cooked, crumbled sausage and 1 small can of diced chilies (mild or hot). Mix well: follow cooking directions of Kansas Fly Pie. Serve with Salsa.

*SCOUTMASTER RANCH EGGS*

*F.G. Bryant and B. Hale*

*I won the SM Cookoff at El Ranch Cima for two years in a row with this.*

**Utensils: 12" Dutch Oven**

**Large Spoon**  
**Knife**  
**Potato Peeler**

**Ingredients: 1 lb. Jimmy Dean Sausage (mild)**

**1 large onion**  
**1 bell pepper**  
**6 to 8 potatoes**  
**1 small bottle Pace picante sauce**  
**8 eggs (chicken)**

Directions:

Brown sausage in dutch oven. (chop it all up like hamberger, don't make it into patties) While that is cooking, peel and cut up potatoes into small 1/4" cubes. Chop up onions and bell pepper. When sausage is brown, drain grease. Dump in potatoes, onions, bell pepper and the bottle of Pace. (pour it out, don't throw the glass in there) Stir that up real good, and put the lid on the pot. You must leave the lid on as the steam helps cook it without burnin. Stir ever so often.

Just before the taters set, smooth the top with the back of the big spoon, and make indentations in the mixture with the eggs, as you break the eggs into them. (Try not to break the yoke so it will be purty.) **PUT THE LID BACK ON SO THE EGGS WILL POACH.** As soon as eggs are set, take off the fire and serve.

This serves well with flour tortillas heated on an inverted dutch oven lid.

*Egg in the Nest*

*Big Bird*

*Griddle*

**1 piece bread, 1 egg, 1 tbs. bacon grease or shortening**

On low heat, melt grease in fry pan. Cut a hole in center of bread for the egg. Place bread in fry pan. Break egg over hole of bread and pour out egg. Fry egg and bread, Flip once and serve.

*Crescent Rolls on a Stick*

*P. D. Boye*

**1 tube of refrigerated Crescent rolls**

**Butter or margarine**

**Jam, jelly or honey**

Using a thick green stick about 1 inch in diameter, wrap the dough for a crescent roll spiral fashion around the tip of the stick. Leave space with the spiral for the heat to reach all of the dough. Press the ends of the dough to the stick to stick to the stick..... Hold the stick over coals for 15-20 min., turning frequently as you salivate. When golden brown, slip the roll of the stick and spread with butter, jam, jelly, or honey. plan for 1-3 rolls per scout.

*Breakfast Cake*

**8 oz. blueberries or other fruit**

**2 cups Bisquick Mix**

**1/4 cup powdered milk**

**2 tbs. sugar**

**dash of cinnamon**

**water**

Heat fruit in large pan. Mix dry ingredients with enough water to make a thick batter. Drop large spoonfuls of batter onto fruit. If you pour, the batter will push the fruit to the sides. Cover and cook until batter becomes a cake.

*Ranch House Potatoes*



**Ham            1/2 cup milk            Tabasco(optional)    Jalapeno (optional)**

Brown the sausage and cook the vegies, drain grease. Mix eggs in a mixing bowl, remove shells, add 1/2 cup milk and stir. Add prepared ingredients then scramble in a frying pan. Add the cheese last. Serve and add seasoning to taste.

*Vienna Toast*

*Skillet*

**2 slices bread            Jam            2 eggs**  
**1 tsp. sugar            1/4 cup milk            cinnamon**  
**powder sugar**

Make a Jam sandwich. Beat 2 eggs per person (4 pieces of toast). Add a little sugar, cinnamon, milk, and water. Dip sandwich in egg mixture, fry like French toast. Dip fried sandwich in powder sugar.

*Scotch Eggs*

*Skillet*

**English muffin            1 egg            butter or margarine**

Cut silver dollar size hole in an English Muffin. Butter both sides. Place on griddle. place egg in hole. Fry both sides, slowly until cooked.

*Real Scotch Eggs            Ann of Palfreyman*

**Hard boiled egg            ground sausage            bread crumbs**

Take a Hard Boiled Egg and mold a shell of ground sausage around the egg, roll in bread crumbs and Bake 25-30 minutes in a reflector oven or Dutch oven. Rotate as needed.

*Dick's Hash*

*Dick Ross    T928*

*Skillet*

**2 potatoes            1 can chunk Ham**  
**1 egg            Shortening/margarine**

Pre-cook 2 potatoes, skins on. Wrap in foil for trip. At camp: melt shortening in fry pan and slice the potato for frying. After browning add chunk ham and egg. Cook until egg is done. Salt and pepper to taste. Alternate: use dried hash brown potatoes on long trips

*True Grits*

*A. J. Anonymous    T928*

*Onepot*

**1/2 cup Instant Grits            1 T. Bacon Bits            dash Molly McButter**

Boil Water, add grits, Bacon Bits, Molly McButter.... eat with an attitude.  
Add cheese or cooked egg as well.

*Granola to Go*                      *Fred Wisenheimer T928*                      *No-Pot*

Place the contents of a box of Granola into a zip-lock type plastic bag. Leave the box at home. Mix instant Milk with cold mountain water the night before and chill in a cold, bubbling mountain stream. Add the cold milk to the Granola the next morning, top with cinnamon sugar and eat.

*Sure Syrup*                      *I. B. Sure T928*                      *Small Pot*

**1 cup packed brown sugar   1 cup water                      1 Tbs. margarine**

Mix and simmer until sugar dissolves. Watch it. Don't Burn it.  
variations:     use apple juice instead of water., Maple flavoring, 1/2 tsp.  
                         cinnamon, or Heat together Karo Syrup and Jam.

*Instant Oatmeal*

**2 cup Regular Oatmeal                      1/4 cup dried fruit (apples, rasins)  
1/4 cup walnuts                                      1/4 cup powdered milk**

*At Home:* Place the ingredients in a blender and chop for a about a minute  
*At Camp:* Place 1/4 cup of mixture with 1/2 cup boiling water in a bowl and mix well. Add more water if too thick. Add sugar and cinnamon if needed.

*Apricot Honey Oatmeal*

**3 1/2 cups water                                      1/2 cup chopped dried apricots  
1/3 cup honey    1/2 teaspoon ground cinnamon  
1/4 teaspoon salt (optional)                      2 cups quick or old-fashioned uncooked oats**

Bring water, apricots, honey, cinnamon and salt to a boil in a 3-quart saucepan. Stir in oats; return to a boil. Reduce heat to medium; cook about 1 minute for quick oats or 5 minutes for old-fashioned oats or until most of the liquid is absorbed, stirring occasionally. Let stand until desired consistency.

Variation: Substitute raisins, dried peaches or pears, dried cranberries, blueberries, dried apples, dates or diced mixed dried fruit for apricots.

Makes 4 (1-cup) servings, each: 280 calories, 2.5 grams fat (25 calories from fat), no cholesterol, 10 milligrams sodium.

*Le Peep's Cinnamon Apples*



*Scrambled Egg Variations*

*Skillet*

Mix with a fork: or mix in ZIP lock Bag, zip tight and mash with fingers or shake it up

- 4 eggs**
- 2 tbs. Dry Milk**
- 4 tbs. water**
- 1/2 tsp. Salt, dash of pepper**

Add one of the following:

- 4 Tbs. Shredded Cheddar, Jack, or Swiss cheese**
- 4 Tbs. Rehydrated mushroom pieces**
- 1 Tbs. Crushed dry parsley or celery leaves**
- 1 Tbs. Bacon bar (Wilson's) or BACOS**
- 3 Tbs. Rinsed shredded dried beef**
- 1/2 tsp. Chili powder**
- 1 Tbs. Dried tomato slices, crushed**

*Hush Puppies Mix*

- |                                |                                 |
|--------------------------------|---------------------------------|
| <b>2 cups yellow corn meal</b> | <b>1 cup flour</b>              |
| <b>4 tsp. Baking powder</b>    | <b>2 tsp. salt</b>              |
| <b>3 Tbs. Sugar</b>            | <b>1/4 cup dry onion flakes</b> |
| <b>3-4 Tbs. Dry egg powder</b> |                                 |

At camp. Measure out one cup of the mixture. Add just enough water to make a thick dough. Drop by spoonful on a well-greased (very generously) hot skillet. Turn to brown both sides  
3 meals worth.

**Trail Meals:**

Trail foods should be quick or no-cook foods for a fast, sit and eat or eat while walking meal. Here are a couple of tables for pick and mix meals. Pick and bag for each meal or keep in a large bag for the trail. Remember that what you don't eat the first couple of days will be left for the last. If you plan for 7 days, don't eat it all the first three.



### Trail Breakfast

**Mix and Match: Pick one from each category.**

dairy	meat	grain	fruit	fun
hard cheese cheese spread string cheese	jerky bacon bar hard salami meat sticks  peanut butter powder eggs eggbeaters	bagel crackers melba toast graham cracker oatmeal, instant grits, instant cream of wheat pilot bread cereal mixes granola bar	dried apples banana chips fruit bits fruit leathers raisins orange cranasins	trail mix choc. granola nuts sunflower seeds pumpkin seeds
<b>drinks</b>				
water Tang tea powder mixes hot chocolate				

### Trail Lunches Pick one from each category.

dairy	meat	grain	fruit	fun
hard cheese cheese spread string cheese	jerky can tuna canned spread hard salami meat sticks  peanut butter jelly	bagel crackers melba toast graham cracker corn chips flour tortillas wheat bread pilot bread pretzels granola bar	dried apples banana chips fruit bits fruit leathers raisins walking apple orange	hard candies GORP trail mix candy bar choc granola nuts sunflower seeds pumpkin seeds cereal mixes
<b>drinks</b>				
water kool aid gator types powder mixes				

#### *Walking Apple*

**1 large apple**  
**raisins**

**Peanut Butter (plain or chunky)**

Take a large crisp, juicy apple and cut the top and stem off. Scoop out the core, leaving the bottom on. In the hole place several tablespoons of peanut butter and raisins. Place the top back on and wrap in foil or other wrapping. Eat while walking down the trail.

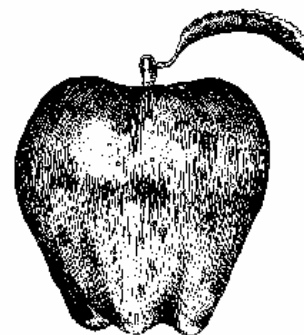





1. Beat together the margarine and 1/2 cup of the brown sugar. Add oats, flour, wheat germ, and orange rind and mix. Pat this mixture into an ungreased 8-inch square pan.

2. Using the same bowl, mix eggs, almonds, raisins, coconut, chocolate chips, and remaining 1/4 cup brown sugar. Pour this mixture over the base and spread evenly. Bake in a preheated 350-degree oven for about 30 to 35 minutes. Cool before cutting.

**Make Your Own Mix**

Cereal	Nuts	Fruit	Sweets
Chex Cereal	Peanuts	Rasins	M&M's
Granola	Almonds	Fruit Bits	chocolate chips
Cheerio's	Mixed Nuts	dried Apple slices	butterscotch chips
Grape Nuts	Macadamina	dried Pear	Reese's Pieces
crackers	Sunflower Kernels	Pineapple	Carob chips
pretzels	Corn Nuts	Apricots	peanut butter chips
Mini Shredded Wheat		Figs	shredded coconut
Croutons		bananna chips	Jelly Beans

Add to this list with your own variations.

## Car camping suggestions

### Suggested Breakfast items

Breakfast Bars, Granola Bars  
 Pop Tarts  
 Canned juice / Dry juice mixes  
 Pancake Mix  
 Granola Mix (see recipe)  
 Powdered Milk  
 Melba Toast  
 Bakery Goods  
 English Muffins w/ butter & Jam  
 Fresh fruit - oranges - grapefruit  
 Hard boiled eggs (done in advance)  
 Milk gravy on pancakes  
 Hot Chocolate  
 Instant Oatmeal (add raisins, brown sugar)  
 Instant Grits  
 Sausage and bacon

### Suggested Lunch Items

dried fruit  
 fresh fruit  
 Triscuit/Wheat thins/ crackers/ pilot biscuits  
 cheese  
 cheese squeeze  
 Hard Boiled eggs (done in advance)  
 Raw Carrots/Broccoli/Cauliflower  
 Peanut Butter  
 Salami Sausage  
 Meat sticks Beef Jerky  
 Canned chicken/SPAM/Tuna  
 Spreadables  
 Canned turkey/ham spreads  
 Chocolate bars  
 chewy brownies or cookies  
 Drink Mix

Car camping allows greater use of fresh foods. You can have elaborate kitchens and expanded menus. It is a great time to try variety of cooking styles and techniques. Propane or charcoal. It is still cooking, try out those backpacking meals before you are 20 miles from the store. The grocery is a good place to buy for the trail. You just have to imagine the food without the package. Get curious and browse through your nearby supermarket. That TRAIL PACK of pancake mix is still only pancake mix.

### *Cheesy Chili Success*

**1 bag Success Rice**  
**1 cup process cheese spread**  
**chopped red bell pepper**

### *Success Rice*

**1 can Hormel Chili No Beans**  
**1/2 cup sour cream**  
**Tomato slices**

Cook rice according to package. Drain and set aside. Combine other ingredients in pan and heat until cheese is melted. Stir to blend well. Serve over rice. Garnish with peppers & tomato. serves 4



*Nachos*

*Campbell*

- |  |  |
|--|--|
| <b>1 can (10.75 oz) Campbell's Condensed Cheddar Cheese Soup</b> |  |
| <b>1/2 cup Salsa</b>   | <b>1 Chopped Tomato</b>                  |
| <b>Sliced green onions</b>                                       | <b>slices pitted ripe olives</b>         |
| <b>1 bag tortilla chips</b>                                      | <b>Chopped green or sweet red pepper</b> |

1. In 1 1/2 quart saucepan, combine soup and salsa. Over low heat, heat through, stir often.
2. Serve over tortilla chips. Top with tomato, green onions, olives and peppers.
3. Add ground beef or chili.

*Aztec Toothpicks*

*In a thousand places.*

- |                    |                     |
|--------------------|---------------------|
| <b>tortillas</b>   | <b>cream cheese</b> |
| <b>brown sugar</b> | <b>cinnamon</b>     |

Heat a white flour tortilla in a skillet; spread cream cheese on tortilla; sprinkle on brown sugar; sprinkle on a small amount of cinnamon; roll up tortilla and pig out.

*Dave's Chili*

*Wendy's dad*

- |  |                               |                                |
|--|-------------------------------|--------------------------------|
| <b>2 lb. ground beef</b>               | <b>2 teaspoons cumin</b>      | <b>1 (15 oz) can red beans</b> |
| <b>1 1/2 teaspoons garlic powder</b>   | <b>1 quart tomato juice</b>   | <b>1 med. onion chopped</b>    |
| <b>1 (29 oz) can tomato puree</b>      | <b>1 teaspoon salt</b>        | <b>1/2 cup diced celery</b>    |
| <b>1/4 cup diced green bell pepper</b> | <b>1/4 cup chili powder</b>   | <b>1/2 teaspoon black</b>      |
| <b>1/8 teaspoon cayenne pepper</b>     | <b>pepper, oregano, sugar</b> |                                |

Brown beef in skillet, drain, then add all the rest into a 6 quart pot, cover and simmer 1 to 1 1/2 hours stirring every 15 minutes. **makes 16 (1 cup) servings.**

*South of the Border Wrap*

- 1 (8-ounce) package red beans and rice mix (recipe developed with Mahatma)**
- 3/4 pound prepared link sausage, diced**
- 1 small onion, chopped**
- 6 large (burrito-size) flour tortillas**
- 2 cups shredded lettuce**
- 1/2 cup chunky salsa**
- 1 cup shredded Mexican cheese blend (such as Cheddar and Monterey Jack)**
- Sliced jalapeño peppers (optional)**

Prepare rice mix according to package directions. While rice is cooking, brown sausage and onion

in medium skillet. Lay tortillas on flat surface. Divide shredded lettuce equally among tortillas. Add equal amounts of rice, sausage-onion mixture, salsa, cheese and peppers. Roll tortillas. Wrap in butcher paper or foil. Makes 6 servings.

*It's a Wrap!*

- 1 (8-ounce) package black beans and rice mix**
- 2 tablespoons vegetable oil**
- 1 cup sliced celery**
- 1 small onion, sliced**
- 2 skinless, boneless chicken breast halves**
- 6 large (burrito-size) flour tortillas**
- Romaine lettuce leaves**
- 1 tomato, diced**
- 1/2 cup chopped cilantro**
- 1 cup shredded Monterey Jack cheese**

Prepare rice mix according to package directions. While rice is cooking, heat oil in medium skillet; sauté celery and onion. Remove from skillet; set aside. In same skillet, brown chicken breasts on both sides, cooking until chicken is no longer pink. Remove from pan. Slice chicken in thin slices.

Lay tortillas on flat surface. Line with lettuce leaves. Divide rice in 6 portions, spreading each on top of a lettuce leaf. Add equal amounts of vegetables and chicken. Add tomato, cilantro and cheese. Roll tortillas. Wrap in butcher paper or foil. Makes 6 servings.

*Fast Chili*

*Troop 421*

*Skillet*

- |                                   |  |
|-----------------------------------|--|
| <b>1 lb. ground beef</b>          | <b>1/4 cup chopped onion</b>                   |
| <b>1 (15 oz) can Kidney beans</b> | <b>chopped celery</b>                          |
| <b>1 can tomato soup</b>          | <b>salt, pepper, and chili powder to taste</b> |

Brown beef, celery and onion in skillet. add Tomato soup and beans. Mix well. Add salt, pepper, and chili powder. Simmer for 5 minutes. servers 4

*Mark's Cookoff Winner!* -- Thanks to Mark A. Michalski, Cubmaster Pack 24, Clinton Valley Council,

***Dutch Oven***

- |                                    |                                     |
|------------------------------------|-------------------------------------|
| <b>1/4 cup olive oil</b>           | <b>2 lbs hot pork sausage</b>       |
| <b>2 lbs cubed stew meat</b>       | <b>1 can rotel tomatos</b>          |
| <b>8 cloves garlic (minced)</b>    | <b>1/3 c chili powder</b>           |
| <b>4 tbs cumin</b>                 | <b>1/4 cup jalapenos (sliced)</b>   |
| <b>1 tsp tabasco sauce</b>         | <b>2 large cans crushed tomatos</b> |
| <b>4 large onions (2 wht-2red)</b> | <b>2 lbs ground chuck</b>           |

<b>Bottle of V8 (hot)</b>	<b>2 cans beef broth</b>
<b>2 large cans of hot chili beans</b>	<b>2 tsp paprika</b>
<b>1 tbs dried red pepper</b>	<b>2 tsp coriander</b>
<b>1 can tomato sauce</b>	<b>6 tbs red wine vinegar</b>

This recipe will feed a whole troop: In a large skillet, saute onions in olive oil, set to the side. In a #14 Dutch Oven, brown pork sausage and chuck and then add stew meat. Season with salt and pepper to taste. Cook for about 20 minutes. Add onion mixture. Stir in spices and cook 5 minutes. Add V8, tomatoes, tomato sauce and beef broth. Bring to boil, lower heat and simmer 1 hour. Stir in garlic, tabasco, peppers and hot chili beans. Simmer another 10 minutes. You can dissolve some corn starch in about a 1/4 cup of warm water and then add to the chili until thick. Sprinkle with cheese, popcorn, frito chips or fixin's of your choice.

We will sometimes cook the meats two days ahead of time, place in gallon freezer bags and keep in the cooler. Also to save time chop the onions and garlic and assemble in a gallon freezer bag ahead of time to cut down on prep time.

*Chili for 8--* Thanks to Pete Farnham, SM, Troop 113, GW District, NCAC, Alexandria, VA,  
***Dutch Oven***

All ingredient amounts are just suggestions; add more or less. It's very free form. You might have your own secret ingredients. Go for it!

<b>1 large onion, sliced/diced</b>	<b>2-3 cloves garlic</b>
<b>1/2 green pepper, diced</b>	<b>1 Tbsp oil.</b>

Saute above in the oil in bottom of Dutch Oven until onions are tender. Add:

**2 lb. lean ground beef .**

Brown thoroughly, salting and peppering to taste. Drain off excess fat. Add:

**2 sm cans tomato paste.**

**1-2 large cans tomatoes** (you can substitute a large jar of spaghetti sauce for the tomatoes and paste).

**3 Tblspns chili powder** (or more, depending on how hot you like it).

Simmer uncovered for 45-60 minutes, cooking off some of liquid. When thickened, add:

**Drained kidney or black beans** (as many as you like; I suggest 2 soup-size cans)..

Cover and simmer 15 or so minutes. .

Serve with rice or pasta, and salad. Use another Dutch Oven to make corn bread. Hot sauce on side is good, too. I showed my scouts how to cook this shortly after I started as SM, and my senior patrol cooks it frequently on campouts now. They scarf it down by the plateful and want more. There rarely is any left over. .

Mmmmmmm...I'm getting hungry. Enjoy!

*One Thousand Chills/One Thousand Spills**Dutch Oven*

*Troop 1000 Dutch Oven Cornmeal Crusted Chili--Thanks to Morton Raban and the Troop 1000*

**1 Cup minced onion (1 medium onion chopped finely)**  
**1/2 Cup diced green and sweet red pepper (include one or two jalapenos if you wish)**  
**1/2 Cup sliced mushrooms (Optional, fresh or canned, use more for vegetarian chili)**  
**2 cloves garlic minced**  
**1 can beef consomme**  
**1000 beans (red kidney, or black beans, actually I use one or two cans)**  
**1 28 oz can whole Roma tomatoes cut into quarters**  
**1 lb ground or cubed meat (beef, chicken or lamb) (may be omitted for vegetarian chili)**  
**1 1/2 Tbs chili powder**  
**1 tsp oregano**  
**1 bay leaf**  
**2 pkgs of Jiffy corn muffin mix ( batter prepared according to package directions)**  
**2 Tbs olive oil**  
**Cayenne pepper to taste .**

Heat Dutch Oven over charcoal. Brown meat (and/or mushrooms) in Olive oil for a few minutes. Add onion and green peppers and fry until Onion is translucent. Finally add garlic, sweet red pepper and jalapeno (if desired) and fry for just a few minutes. If fatty hamburger was used be sure pour off most of the fat. (Fat can be removed with a large spoon or bulb baster). Add the can of consomme and scrape the solids from the bottom of the dutch oven. Add beans, tomatoes (including juices), one and one half cans of water, and spices. Cover the Dutch oven. Meanwhile make up the batter for the corn bread or corn muffins using package directions. Dilute about 1/3 Cup corn muffin mix with 1/2 can of water. Add to the chili broth with stirring. Correct spices and spoon in the remaining prepared corn muffin so that it floats on top of the chili. Cover the Dutch oven and put charcoal on the top. Cook for about 30-40 min so that the cornbread is slightly browned and crusty. Serve chili together with cornbread in cups or bowls.

**Notes:**

Shredded cheese, chopped peppers or canned corn may be added to corn muffin crust.

Without added Cayenne the chili is mild enough to be served to children; addition of 1/4 t of Cayenne makes a very spicy chili.

It makes sense to spend the extra money and get lean ground beef (ground round) since it is not much fun trying to remove the extra fat.

This recipe won the weekly best chili award during our troops week at Summer Camp at Lost Lake Scout Reservation Clinton Valley Council). However, honesty forces me to admit that it was the only entrant ;-)" Morton Raban

*Texas Chili*

- |  |                      |
|--|----------------------|
| <b>2 lb lean chuch roast</b>                 | <b>bacon grease</b>  |
| <b>6 jalapino pepers, seeded and chopped</b> | <b>1 tbs cumin</b>   |
| <b>1 (20 oz) can tomatoes, chopped</b>       | <b>1 large onion</b> |
| <b>6 cloves garlic, minced</b>               | <b>2 tsp salt</b>    |
| <b>4 tbs chili powder</b>                    | <b>1 tbs oregano</b> |

Brown meat, garlic and onions in bacon grease. Add Jalapino pepers and mix well. Add remaining ingredients, cover and cook 1 hour.

*Homestyle Chili*

- |                                    |                                       |
|------------------------------------|---------------------------------------|
| <b>1 lb gound beef</b>             | <b>3 cloves garlic, minced</b>        |
| <b>2 tbs chili powder</b>          | <b>1 (20oz) can tomatoes, chopped</b> |
| <b>1 c red wine (dry)</b>          | <b>1 lb uncooked kidney beans</b>     |
| <b>1 lg yellow onion, chopped</b>  | <b>1 tbs cumin</b>                    |
| <b>1 tbs cumin</b>                 | <b>1 tbs worcestershire sauce</b>     |
| <b>1 green bell peper, chopped</b> | <b>salt &amp; peper to taste</b>      |

Cover beans with 2-3" water. Bring to boil, remove from heat and let stand 1 hour. Drain and set aside. Brown ground beef with onion and garlic. Add remaining ingredients. Cover and simmer about 1 hour. Variations: Use black beans instead of kidney beans. Add fresh ground ginger, paprika or cocoa.  
Cook, eat and enjoy!!!

*Texas Lava Chili*-- Thanks to Don Houston  
Yields 12 Servings

*Dutch Oven*

- |   |   |
|---|---|
| <b>4 Lb Boneless Sirloin Roast</b>  | <b>2 Lb Boneless Venison Roast</b>          |
| <b>1/2 Cup Regular Coca Cola</b>  | <b>2 Tbls Tabasco Sauce</b>                 |
| <b>4 Medium Onions, Chopped Coarse</b>                                    | <b>1 1/2 Cups Tomato Paste</b>              |
| <b>5 Cloves Garlic, Minced</b>  | <b>1 Tbls Cayenne Flakes</b>                |
| <b>2 Cups Tomato Sauce</b>  | <b>1 tsp Allspice</b>                       |
| <b>1 Tbls Cumin, Ground</b>   | <b>2 Tbls Fresh Cilantro, Chopped</b>       |
| <b>2 Tbls Cumin, Ground</b>   | <b>2 Tbls Peanut Oil</b>                    |
| <b>1 Tbls Cumin, Ground</b>   | <b>6 Ancho Peppers, Dried &amp; Chopped</b> |
| <b>6 Green Jalapeno Peppers Seeded &amp; Diced (or sub your own kind)</b> |   |
| <b>1 Cup Red Bell Pepper, Cored Seeded &amp; Chopped</b>                  |   |
| <b>1 Cup Green Bell Pepper, Cored &amp; Seeded &amp; Chopped</b>          |   |

Cut all the meat into 1/4 " cubes. Put the peanut oil in a large, cast iron pot. Heat over medium high heat. Add the onions, garlic, meat cubes and the first measure of cumin. Cook until the meat is browned. Add the tomato sauce, beer, bourbon, Coca-Cola, chile peppers, Tabasco, cayenne,

allspice, cilantro and second measure of cumin. Cover. Cook over low heat for 45 minutes, stirring often. Uncover. Cook for another 20 minutes. Stir in the third measure of cumin. Serve.

*Beef Stew and Dumplings*

*Troop 421*

*Onepot*

- 1 - 1 1/2 lb can beef stew**
- 1 pkg. biscuits**

Place stew in 3 quart saucepan. Add 1/4 cup water and stir. Bring to a boil over medium heat. Place biscuits on simmering stew. Cover tightly. Turn heat to low and simmer 10 to 15 minutes. servers 4

*Jiffy Hamburger Stew*

*Troop 421*

*Onepot*

- 1 lb lean hamburger**
- 1 can tomato juice**
- 1 pkg. frozen mixed vegetables**
- 1 can stewed tomatoes**

Brown hamburger, pour off fat. Cook vegetables according to package directions. Add hamburger, tomato juice and tomatoes. Simmer 10 to 15 minutes. servers 6

**editor's note** Amount of tomato juice is not listed. Start with 6 oz.; you can always add more if too thick.

*Pineapple Ham Crescents*

*Count DelMonte*

*Reflector Oven*

- 1 can 15.25 oz Pineapple Spears in Juice**
- 8 thin slices ham, 2-inches wide**
- 1 Tbs. Dijon mustard**
- 1 can (8 oz) refrigerated crescent rolls**
- 8 slices Swiss cheese, 2-inches wide**

Drain pineapple well, reserving juice. Reserve 2 spears for sauce; chop and set aside. Unroll crescent rolls. Wrap ham and cheese around pineapple. Place at widest part of crescent and roll-up. Place on baking sheet. Bake at 375°F, 12 to 15 minutes or until golden. In sauce pan, boil the reserved juice with mustard until thickened, about 10 min., stirring frequently. Stir in chopped pineapple. Serve with crescents. Makes 8 sandwiches.

*Microwave Beef Jerky*

*Nabisco foods*

- 1 lb. flank steak**
- 1 T. seasoned salt**
- 2 T. Wright's Natural Hickory seasoning**
- 2 T. soy sauce**
- 1/4 tsp. ground red pepper**

Trim meat of all visible fat. Slice beef across grain into 1/8 inch strips; place in nonmetal dish. Blend remaining ingredients; pour over meat, stirring to coat well. Cover and chill at least 8 hours.

Arrange a third of the meat strips on microwave-safe rack or paper-towel-lined microwave-safe plate. Cover with paper towel. Microwave at HIGH 5 minutes; turn over strips. Microwave 3-3 1/2 more minutes or until meat is well cooked and firm, but not crisp. Repeat with remaining strips. Cool completely. Cover and store in refrigerator for up to 1 week. *Watch the last few minutes...*

*Rice & Freebies*

*The Road King*

- 1 Box instant rice** - bought with triple coupons
- 5 packets taco sauce** - Taco Bell
- 2 packets Chile Sauce** - Wendy's
- 3 packets bacon bits** - McDonald's
- Salt & pepper packets** - Kentucky Fried
- 2 honey packets** - Kentucky Fried
- Road Kill** - only if fresh (only kidding)

Cook the rice, add the sauces and stuff. Eat if you dare.

*Beaubian Beans*

*Philmont*

- 1 can Pork and Beans**                      **1/4 cup Brown Sugar**                      **1/4 cup BBQ sauce**
- 2 TBL. onion flakes**

Mix all in one pot, remove can, heat for a few minutes until onions rehydrate. serve around campfire singing tunes..

*Jambalayia*

*Dutch Oven*

Yield: 8 Servings

- 1/2 lb pork tenderloin, chopped**
- 4 cloves garlic, minced**
- 1/2 ts Pepper**
- 6 c Uncooked Rice**
- 2 lb okra, cut in 1/4" slices**
- 1/2 c celery, chopped**
- 2 cloves garlic, minced**
- 1/4 c vegetable oil**
- 1 bunch green onions, chopped**
- 1 ts garlic salt**
- 1/4 ts red pepper**
- 1 c chopped celery**
- 8 oz Tomato sauce**
- 1/2 ts dried Thyme**
- 1/4 c Flour**
- 2 md onions, chopped**
- 3 tb flour**
- 1/2 lb smoked sausage, 1/2" slices**
- 1 c chopped onion**
- 1 tb chopped parsley**
- 1/2 ts paprika**

Cook sausage and pork until browned; drain well and set aside. Cook rice according to package directions and set aside. Heat oil in Dutch oven, add flour and cook over med.-high heat stirring constantly, until roux turns dark brown. Stir in onion, celery, 1/2 of green onion, garlic and parsley. Cook over md heat 10 minutes stirring frequently. Add tomato sauce and seasonings. Reduce heat and simmer 5 minutes, stirring occasionally. Stir in meat and remaining green onions. Cook until

*Arroz con Pollo* Chicken with Rice

- 1 2 1/2 to 3 lb. Broiler-fryer chicken, cut up (can be pre-boned pieces)
- 2 tbls cooking oil
- 1 1/2 cups long grain rice
- 1 cup chopped onion
- 2 cloves garlic, minced
- 3 cups water
- 1 8 oz. Can tomatoes, cut up
- 1 tlbs. Instant chicken bouillon granules
- 1 teaspoon salt
- 1/4 teaspoon pepper
- 1/4 teaspoon coriander
- 1 cup frozen peas
- 1 2 oz can sliced pimientos

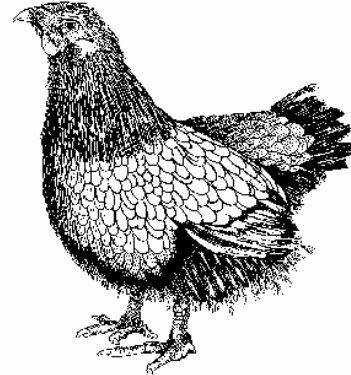

Sprinkle chicken lightly with salt. In a 12-inch skillet brown chicken in hot oil about 15 minutes. Remove chicken from pan. In drippings remaining in pan, cook rice, onion, and garlic until rice is golden. Add water, undrained tomatoes, bouillon granules, salt, pepper, and coriander. Bring to boiling, stir well. Arrange chicken atop rice mixture. Cover and simmer 30-35 minutes or until chicken is tender. Add peas. Cover and cook 5 minutes more. Garnish with pimiento strips. Makes 4-6 servings.

*Chicken Quesadillas* James Thorne T928

- |   |                 |                            |
|---|-----------------|----------------------------|
| 2 tortillas for each quesadilla           | 1 whole chicken | 2 lb. Monterey Jack cheese |
| Salsa, hot or mild                        | 1 onion         | 1 Green pepper             |
| 2 Tbs. finely chopped cilantro or parsley |                 | oil                        |

Cook a whole cleaned chicken in large pot of water until meat falls from bone, about 2 hours. Debone and chop chicken, set meat aside, save Stock for tomorrow's soup. Grate the cheese, set aside. Simmer sliced onions and green peppers with a little oil. Add salsa and chicken. On a lightly oiled griddle, heat tortilla, add meat mixture and grated cheese. Top with another tortilla. Flip and melt cheese. Cut into quarters and serve. Add Guacamole, sour cream, lettuce, Eat

*Shrimp Quesadillas* James Thorne T928

- |   |                            |                |
|---|----------------------------|----------------|
| 1 cup coarsely chopped cooked shrimp      | 1 onion                    | 1 Green pepper |
| 2 tortillas for each quesadilla           | 2 lb. Monterey Jack cheese | oil            |
| 2 Tbs. finely chopped cilantro or parsley | Salsa, hot or mild         |                |

Cook and clean shrimp. Chop set aside. Grate the cheese, set aside. Simmer sliced onions and green peppers with a little oil. Add salsa and shrimp. On a lightly oiled griddle, heat tortilla, add meat mixture and grated cheese. Top with another tortilla. Flip and melt cheese. Cut into quarters and serve. Add Guacamole, sour cream, lettuce, Eat

*Davy Jones' Supper*

**1/2 lb. elbow macaroni**  
**1/4 cup milk**  
**1 can cream of shrimp soup**  
**1/2 cup sour cream**  
**1 tablespoon mustard**  
**1/4 teaspoon salt**  
**1 teaspoon Worcestershire sauce.**

*Creamettes*

**2 tablespoons butter or margarine**  
**1/4 cup chopped onion or dried onion flakes**  
**1/4 cup chopped green bell pepper**  
**(1) 6 oz can of shrimp salmon or tuna**  
**4 oz can of mushroom stems and pieces drained**  
**2 tablespoons sliced green olives**

*Kettle*

Cook macaroni and drain. In medium skillet, melt butter and cook onion and bell peppers, if flaked, rehydrate first. Blend in milk and soup, heat through. Combine macaroni, soup mixture and remaining ingredients, mix well and heat until thickening. Simmer... 4-6 servings.

*Chili Soup with Macaroni (2 or 3 servings)*

Combine in pint plastic zipper bag:

<b>1/2 cup macaroni</b>	<b>1/3 cup dried diced tomato</b>
<b>1/4 cup dried cooked or canned pinto beans</b>	<b>1/4 cup dried cooked ground beef</b>
<b>1/2 teaspoon crumbled dried parsley leaves</b>	<b>2 teaspoons dried chopped onion</b>
<b>1/2 teaspoon beef bouillon granules</b>	
<b>2 tablespoons dried diced red or green bell peppers</b>	
<b>1/2 package (1.125-ounce package) taco seasoning mix</b>	
<b>Half of the leather from an 8-ounce can tomato sauce</b>	

At camp:

In medium pot, boil 2-1/2 cups water. Add mix; stir well. Cover; remove from heat and let stand about 10 minutes. Stir well and return to boiling. Reduce heat and simmer, stirring occasionally, until macaroni is tender, 5 to 10 minutes.

*Mexican Rice Mix*

<b>4 c Raw Long Grain Rice</b>	<b>4 ts Salt</b>
<b>1 ts Dried Basil</b>	<b>1/2 c Green Pepper Flakes</b>
<b>5 ts Parsley Flakes</b>	

Combine all ingredients in a large bowl; stir until well blended. Put about 1 1/2 cups of mix into three 1-pint airtight containers and label as Mexican Rice Mix. Store in a cool, dry place and use within 6 to 8 months.

Makes about 4 1/2 cups of mix.

**Mexican Rice:** Combine 1 1/2 cups of mix, 2 cups cold water, and 1 T butter or margarine in a medium saucepan. Bring to a boil over high heat; cover and reduce heat. Cook for 15 to 25 minutes, until liquid is absorbed. Makes 4 to 6 servings.

*Macho Nacho*

**1 can Chili, no beans                      1/2 cup shredded cheese                      1/2 pk tortilla chips**

Spoon chili over chips. Sprinkle with cheese. Heat in microwave or reflector oven to melt cheese.  
 Categories: Appetizer,      Yield: 4

*BLT Sandwiches (4)*                      *Troop 421*

**1 lb bacon                      lettuce and tomatoes                      1 loaf bread                      miracle whip**

Fry bacon to desired texture. Place bacon on slice of bread and cover with lettuce, tomatoes and miracle whip. Try using toast or canadian bacon.

*Grilled Chess Sandwiches*                      *Troop 421*

**1 loaf bread                      sliced cheese                      Butter or margarine                      Pickles  
 Chips**

Heat griddle or frying pan. Spray or oil the pan. Lightly butter bread and place onto pan butter side down. Place 1 slice of cheese on bread and then cover with another slice of buttered bread. Butter side up this time. Brown, then flip and brown the other side.

*Hawaiian Chicken*

**3 boneless chicken breasts - cut in half                      1 sweet green pepper                      vegetable. oil  
 1 sweet red pepper                      8 oz. can pineapple chunks  
 2 oz. apple juice                      1 large red onion                      1 cup minute rice**

Brown chicken in oil. add pineapple chunks and juice. Ring cut the onion and peppers and cook. Cover and simmer 20 minutes. Make the rice and serve chicken over bed of rice.

*Burp Burritos*                      *Wyatt Burp T928*

**1 cup dried refried beans                      10-12 flour tortillas                      cheese  
 hot sauce/salsa                      1 head lettuce                      2 cups water**

Boil water and add beans and let stand. Warm the tortillas. Place fixings on tortillas and eat.

*Turkey Vulture Casserole*                      *PTC*

**2 cans turkey, 1 pkg. elbow macaroni 1 can cream of celery soup  
1 pkg. vegetable soup mix**

Cook the macaroni, drain the water, saving 1 cup. Add the soup mix with the water, simmer for 2 minutes. Add the can of cream of celery soup and the canned turkey. Heat to bubbling and serve.

*English Muffin Pizza* *Troop 421*

**1 pkg English Muffins pizza sauce  
5 oz sliced pepperoni cooking spray  
12 oz grated mozzarella cheese**

place muffin in a greased pan face down until brown, then remove. Turn over the muffin and spread the browned side with the pizza sauce, pepperoni and cheese. Use a piece of foil or a pie pan and cover the pizza. Place back in pan and brown the other side, cook 10-12 min. until cheese melts.

*Laredo Supper* *Kettle*

**1 lb Ground Beef 1 can tomatoes cut up and drained  
1 chopped onion 1 - 8 oz jar of Cheese Whiz  
1 chopped bell pepper 1 tbsp chili powder  
1 can Ranch Style Beans**

Brown beef in skillet or pot. Add onion and bell pepper, cook until onions are tender. Add remaining ingredients, simmer 10 minutes. Serve with tortilla chips. Serves 4.

*Skillet Spagetti* *Kettle*

**1 lb Ground Beef 1 tsp Dried Oregano  
1 - 6 oz can Tomato Paste 2 tbsp Minced Onion  
1 - 3 oz can Tomato Juice 1 - 7 oz package Uncooked spaghetti  
5 cups water 1 1/2 tsp Chili Powder  
1 tsp Garlic Salt 1 tsp Sugar  
Parmesan Cheese**

In large pot or skillet brown ground beef. Add remaining ingredients, except spaghetti. Cover and bring to boil; reduce heat and simmer for 10 minutes. Add Spaghetti and stir to separate strands. Simmer covered 12 to 20 minutes until spaghetti is tender. Serve with Parmesan Cheese. Serves 4 to 6.

*Favorite Beef Stew* *Kettle*

**2 lbs stew meat or chuck (cubed)**  
**1/4 cup flour**  
**1/2 tsp pepper**  
**3 tbsp oil**  
**3 cups hot water**  
**1 bay leaf**  
**Oregano**

**6 medium potatoes, quartered**  
**2 tsp salt**  
**6-8 carrots cubed**  
**1 large Onion (cubed)**  
**1/2 chopped green pepper**  
**Pinch Thyme**

Coat meat in flour, salt, & Pepper. Brown in oil in large pot. Add water & herbs. Bring to a boil, lower heat and simmer 1 hour or until meat is nearly tender. Add vegetables, bring to boil, then lower to simmer 25-30 minutes until vegetables are tender. serves 8-10.

*Chili*

*Kettle*

**4 lbs Ground Beef**  
**1 chopped Onion**  
**2 cloves garlic, ground**  
**3 cans Ranch style Beans**  
**1 tsp cumin**  
**salt to taste**

**3 - 16 oz cans tomatoes**  
**2-6 dashes hot sause**  
**2 cups hot water**  
**1 tsp oregano, ground**  
**6 tsps. chili powder**

Brown meat and onions in a large pot until meat is done. add remaining ingredients, bring to boil, lower heat and simmer 45 minutes to 1 hour. Serves 6.

Chuck Wagon Steak

*Kettle*

**1 cup catsup**  
**1/2 cup water**  
**1/4 cup vinegar**  
**1/4 cup chopped onion**  
**1/4 cup chopped bell pepper**  
**1 1/2 tbsp Worestershire sauce**

**1 tbsp prepared mustard**  
**2 tbsp brown sugar**  
**1/2 tsp salt**  
**1/2 tsp pepper**  
**4 lbs. Round stead, 1/2" cubes**

Pound meat to tenderize, then brown in large pot or skillet. Mix all remaining ingredients and pour over meat; bring to boil. Turn to simmer and cook slowly for 2-3 hours. You can cook with lid on for first portion of cooking time but remove lid for last hour of cooking. Steak is delicious and tender. Would be good served with rice or noodles. Serves 10, 6oz portions.

Easy Sloppy Joes

*Kettle*

**2 lbs. ground beef**  
**1 (12 oz) bottle Bar B-Que Sauce**

**8 hamburger buns**

Brown meat in skillet until well done, lower heat, pour in sauce, heat until bubbly hot and serve on buns. Serves 8.

## ONE POT DINNERS

The idea is to create a stew or casserole in one pot. A mixture of starches, proteins, vegetables, and spices or a delectable sauce can become a gourmet feast. The following recipes are examples. Use the Chart to help create your own specialties.

One pot dinners can be easy to prepare with a little thought before hand. Which foods need to cook longer? - Start them first. How much water is needed? - Is the pot big enough?

Try to maintain texture in the food. Mush is mush and no amount of spices will dress it up.

Plastic freezer bags can serve for carrying and mixing items such as instant potatoes. Reduce the cleanup, add the boiling water to the bag and mix. This works with quick rice as well.

### Directions:

1. Select and assemble your ingredients from the grocery store, camping outlet or food co-op. Use amounts of each ingredient to suit individual preferences, servings, and appetites.  
7 oz pasta, 1 lb. meat, 2 cups vegetables, 1 cup sauce, & seasonings should feed 4-5
2. Determine the order of preparation based on the cooking times of each ingredient. Place items with similar cooking times and methods together in a plastic bag. Noodles may take 10 minutes, Instant Mashed Potatoes only the time to boil water.
3. Put the bulkiest or main items in a large bag, and put the other items in smaller bags and seal them. Place these smaller bags inside the large bag and seal it.
4. Check the instructions for each sauce or mix to be sure you include any extra items such as butter, dry milk, etc. If you keep all your oil in one container, then write on the bag the extra ingredient.
5. Decide how much water you need, based on each ingredient. Too much water will change Instant mashed potatoes to Potato soup.
6. Write instructions on each package for the meal. Include the order of preparation, cooking times, ingredients not included in the bags, etc. Use a waterproof pen. or cut from boxes and placed in bag
7. Include the instructions for each package with the package. Place the instructions for the whole meal with the large bag.
8. Label each bag  
i.e. Large bag can be labeled "dinner Day 3" with list of contents  
Orange drink, chicken soup, Mac & cheese, chocolate pudding

# One Pot dinners

take one from each column

BASE	VEGETABLE	MEAT	SAUCE	SPICE	TOPPING
<b>7oz - 1 lb</b>	<b>1-2 cups</b>	<b>5 oz-1 lb</b>	<b>1 cup</b>	<b>1-2 tbsp</b>	<b>1-2 tbsp</b>
Spaghetti	<i>fresh</i>	ground beef	cheese	oregano	nuts
Thin Spaghetti	carrots	can beef	sour-cream	herbs	toasted
Vermicelli	potatoes	can chicken	stroganoff	sage	sunflower
Capellini	summer squash	can turkey	spaghetti	basil	pumpkin
Fettuccini	onions	dried chipped beef	dry soup mix	salt, pepper	coconut
Macaroni Ribbons	cucumbers	can meat spread	miso powder	poultry seasoning	sesame seeds
Egg Noodles	<i>frozen</i>	stew meat	gravy mixes	garlic salt	margarine
Linguine	for short trips &	hard salami	curry	onion salt	cheese
Elbow Macaroni	cold weather	Vienna sausage	sweet & sour	chili powder	catsup packets
Rotini	<i>freeze dried</i>	SPAM	au jus	butter buds	bacon bits
Small Shells	peas	jerky	teriyaki	soy sauce	croutons
Juniorettes	gr. beans	<b>canned fish</b>		<b>bouillon</b>	dumplings
Pasta Nuggets	corn	clams	<b>thickeners</b>	chicken	
Kluski noodles		tuna	cornstarch	beef	wheat germ
Rigatoni	<i>home dried</i>	salmon	flour	vegetable	
Mostaccioli	onions	sardines	cornmeal	<b>mixes</b>	
Ziti	mushrooms	crab	<b>SOUPS</b>	chili	
Ready-cut Spaghetti	mixed vegetable flakes	shrimp	Cream of Mushroom	taco	dried fruit bits
Rotelle	soup blends	pepperoni	Tomato	sloppy Joe	raisins
Rainbow Rotini	pepper flakes	<b>freeze dried</b>	creamed corn		
Medium Shells	celery flakes	ham	Tomato juice		
Cous Cous	can onion rings	beef			
Acini di Pepe		chicken	Cheddar		
Rosmarina		shrimp	cheese		
A-B-C- noodles		dried fish	soup		
Rings		smoked fish			
Ramen noodles	chow mein noodles	bacon bar			
Quick Rice	### Helper's	<b>TVP</b>			
Rice-A-Roni	Stuffing	beef flavor			
Instant	box mixes	chicken flavor			
Potatoes	Mac & cheese				
Quick Grits	rice & ###				
	noodles & ###				

Amounts will depend on # of servings and appetite.

*Frontier Dinner*

*Creamettes*

**ONE POT**

**7 oz or 1/2 lb. package of Elbow Macaroni**      **1 can tomato soup**  
**1 can Chili with beans**

Prepare Macaroni by boiling till done, drain. In a large saucepan, blend chili and tomato soup; heat through, Add macaroni; heat through.      4-6 servings

*Rice N' Chicken*

*T928*

**ONE POT**

**1-1/3 cups instant rice**      **2 Tbls. Dry onion flakes**      **1 can boned chicken**  
**1/2 tsp. Sage**      **2 tsp. Instant bouillon**

Boil 1-2/3 cups water. Add dry ingredients and can chicken. Simmer 5 min.  
 Variations: Tuna and dry mushrooms      2 servings

*Chicken Fried Rice*

*Matt Schmitt T928*

**ONE POT**

**2 cups cooked instant rice**      **margarine / oil 1 Tsp.**  
**dried onion flakes**      **2-3 Soy Sauce packets, Chinese Rest. Supply**  
**vegetable. mix peas & carrots**      **canned chicken 8 oz.**      **2 eggs**

Boil water and cook rice with dried onion flakes, then fry in oil in large fry pan. Add soy sauce, vegetables. and chicken. Break eggs over heated mixture and cook eggs as you stir. **Serves 4.**

*Spanish Fried Rice* *A traditional Spanish Chinese Dish*

**ONE POT**

**2 cups cooked instant rice**      **margarine / oil 1 Tsp.**  
**1/2 cup Salsa**      **dried onion flakes**      **2 eggs**

Boil water and cook rice with dried onion flakes, then fry in oil in large fry pan. Add Salsa. Break eggs over heated mixture and cook eggs as you stir. **Serves 4.**

*Scoutmaster Stew*

*Richard Welch*

*T928*

**ONEPOT**

**1 can soup**      **1 can vegetables**      **1 can potatoes**      **1 can Dinty Moore**

Open cans, slice the potatoes, put in pot, heat, eat with copious amounts of grunts and growls.

*Tortilla Italliano*

*Milo Gomez*

**1 can pizza sauce**      **grated mozzarella cheese**      **1 tbs. cooking oil**  
**flour tortillas 9"**      **pizza toppings, sausage, onion, mushroom.....**

Cook the sausage, mushrooms, and onions. Oil skillet and put tortilla on the sauce, toppings and cheese. Put 2nd tortilla on top and heat for 2 minutes, flip and heat 3 minutes more or less.

*Souper Rice*

*Minute Rice*

**ONEPOT**

**1 can Cream of Mushroom soup**  
**1 1/3 cans water or milk**

**2 cups Minute Rice, uncooked**

Open cans, heat soup and water to a boil and add 2 cups of Minute Rice. Cover and set aside for 5 minutes. Fluff and serve. 4 servings. *Try other Cream Soups..*

*BBQ Rice and Beans*

*Minute Rice*

**ONEPOT**

**1-1/2 cups Minute Rice**  
**2 Tbls. dried onion flakes**  
**1 Tbls oil**  
**1 beef bouillon cube**  
**1/2 cup barbecue sauce or 4-6 tubs from McD's or such.**

**1 small can Kidney beans, drained**  
**2 Tbls dried Green Peppers**  
**1-1/2 cups water**  
**1/4 tsp. garlic powder**

Rehydrate onion flakes and green peppers in boiling water. Stir in beans, BBQ sauce, garlic powder, bouillon cube. Bring to boil. Stir in Rice and cover. Remove from heat. Stand 5 minutes Fluff with fork. serves 4-6.

*Ute Park Pot*

*Phil Monte T928*

**ONEPOT**

**2 1/4 cups elbow macaroni**  
**2 #27 cans whole tomatoes**  
**5 cups water**

**3 tsp. salt**  
**1/2 lb. bacon**

**1 onion**  
**salt and pepper**

Dice the bacon and onions, fry bacon and onions until crisp. Boil the macaroni in salted water until al dente. Drain, add bacon, onions, and whole tomatoes. Stir, breaking up tomatoes. Bring to boil. Salt and pepper to taste.

**More ONE POTS**

**Mac and.....**

*Kraft*

1 box macaroni and cheese, 1 can of tuna, chicken, or turkey, 1 small can vegetable. Cook the macaroni and add some onion flakes, drain and add the cheese mix, add the can meat and vegetable., add pepper. Heat and eat. ~ **4 servings**

MAC and .....	1 cup Meat	1 cup Vegetables	some EXTRAS
1 box of Mac & Cheese	ground beef	stewed tomatoes	1 t. chili powder
	chicken	broccoli	2 t. mustard
	ham or SPAM	red pepper	1/4 cup Miracle Whip
	tuna	peas	1/4 t. Italian seasoning
	ground beef or turkey	peas & carrots	1/8 t. pepper

*Devil' Thumb Stew*

**ONEPOT**

**4 cups water**                      **1 pkg. vegetable beef soup mix**  
**1 box Mac and cheese**        **1 can tuna**                      **1/2 cup instant rice**

To boiling water add soup mix and macaroni. Simmer until macaroni is almost done. Add cheese and tuna- mix. Then add rice. Cook until macaroni and rice are done **Serves 4.**

*Just a Minute*

**ONEPOT**

A cup of Minute Rice or other quick cooking rice can be made in a freezer bag. But add a equally quick instant soup mix and you can create a meal.

Rice	Soup Mix	Protein
	vegetable soup mix	can tuna
1/2 cup Minute Rice	onion soup mix	can ham
= 1 serving	chicken bouillon	can chicken
	gravy mix	TVP
	vegetable beef soup mix	can turkey

*Gooder Goulash*

*Dan and PatT928*

**ONEPOT**

**1 (5 oz) can water chestnuts**        **1 can chicken**                      **2 pkg. ramen noodles, chicken**

Cook noodles as usual. At end, add drained water chestnuts and put stove on simmer. Add chicken and remove from stove. Stir and enjoy. Serves 2-3

**And More's**

based on LIPTON packaged noodles and rice. Prepare noodles and rice as directed and add more..... **Serves 2-3.**

Lipton Alfredo Carbonara *AND* 1/2 cup milk, 1 T. margarine, 1 T. onion flakes

Lipton Alfredo *AND* 1/2 cup milk, 1 T. margarine, 1 T. onion flakes, 1 can chunk chicken.

Lipton Cajun Style Rice & Beans *AND* 1 T. onion flakes, 2 T. margarine, 1 T. dried green peppers, 1 package Tomato Cup of Soup Mix, 1 can shrimp.

Lipton Stroganoff *AND* 1 T onion flakes, 1 package freeze dried (FD) beef, 1/2 cup milk.

Lipton Chicken & Rice *AND* 1 package freeze dried (FD) chicken, or 1 small can chicken, 1 package Vegetable soup mix.

Lipton Mushroom & Rice *AND* 1 package Pea Cup of Soup, 1/3 cup crumbled bacon or bacon bits.

Lipton Chicken Broccoli & Noodles *AND* 1/2 cup milk, 1 T. dried green peppers, 2 T. parmesan cheese, garlic salt, 2 T margarine.

Lipton Beef Rice *AND* 1 package freeze dried (FD) beef, 1 T. onion flakes.

*Patrick J's Dindin*

*Patrick Jennings T928*

**ONEPOT**

**1@ 4 oz. can chicken**

**1/4 lb. spaghetti**

**oil**

**3/4 cup instant rice**

**soy sauce**

**spice mix**

**1 packet spaghetti sauce**

**1 small can tomato paste**

Boil 1 3/4 cups water, mix sauce, pasta, and spice. Add rice and chicken. Cover and remove from heat. Let stand 5 min. and eat.

*The Rice Stuff*

*Dennis A. Schmitt T928*

**ONEPOT**

**1 bag Success boil in bag rice**

**1 bag Campbell's instant vegetable soup mix**

**1 Tablespoon onion flakes**

**1 (4 oz) can chunk chicken**

**1 chicken bouillon cube.**

Boil the rice, set aside the cooked rice and with 1 cup of boiling water mix the bouillon, soup mix, and chicken. Pour over the rice. Season to taste. **Serves 2-3.**

*Potato Soup*

*Dennis A. Schmitt T928*

**ONEPOT**

**1 T. dried onion flakes**

**1 Box Betty Crocker Hash Brown Potatoes**

**1 tsp. dried bell peppers**

**dash cooking oil**

**crumbled bacon**

**dash salt and pepper.**



Add chopped onion to the pan and cook 1 to 2 minutes. Stir in coffee, chili sauce, molasses, Worcestershire and reserved beef and bacon. Cover and simmer over low heat 1 hour, stirring occasionally.

Add boiling onions and 3 cups water. Simmer covered 30 minutes. Stir in potatoes, carrots and more water if necessary. Continue to simmer the stew, partially covered, about 30 minutes or until potatoes and carrots are tender. Add salt to taste and serve garnished with fresh parsley. Makes 6 servings.

*Chunks*

*Campbell's Soup*

**ONEPOT**

**1 cup Quick Rice**

**1 can of Campbell's Chunky Beef Soup**

Heated and served over rice. **Serves 2**

*Green Goo*

*Dennis A. Schmitt T928*

**ONEPOT**

**1 bag Success boil-in-bag rice,  
1 T. onion flakes,**

**2 packages Lipton's Green Pea Cup-of-Soup Mix,  
1 (4 oz) can Chunk Ham.**

Boil the rice, set aside the cooked rice and with 2 cups of the boiling water mix the onion, soup mix and Ham. Pour over the rice. Season to taste. **Serves 2-3.**

*Mexican Rice & Beef*

*Dennis A. Schmitt T928*

**ONEPOT**

**1/2 lb. ground beef  
1 (8 oz). can tomato sauce**

**4 whole scallions,      1+1/2 tsp. chili powder  
1/2 cup water,          3/4 cup Minute Rice**

Brown beef & scallions, add tomato, water, chili powder. Bring to boil. Stir in rice, cover, stand for 5 min. Serve with tortilla chips. **Serves 4**  
alternate: FD beef and dried onions.

*Chicken-Flavored Rice Mix*

Servings: 12

**4 c Uncooked Long Grain Rice  
2 ts Dried Parsley Flakes  
2 ts Dried Tarragon**

**1 ts Salt  
4 Tb Instant Chicken Bouillon  
1/4 ts White Pepper**

1. Combine all ingredients in a large bowl. Stir until evenly distributed.  
2. Put about 1 1/3 cups into three 1-pint containers and label. Store in a cool, dry place and use within 6 to 8 months.

Makes about 4 cups of mix.

*CHICKEN-FLAVORED RICE:*

Mix 1 1/3 cups rice mix with 2 cups cold water and 1 Tb butter or margarine in a medium saucepan. Bring water to a boil over high heat. Cover and reduce the heat and cook for 15 to 25 minutes, until liquid is absorbed. Add canned chicken chunks as desired. Makes 4 to 6 servings.

*Dill-Lemon Rice Mix*

Servings: 12

**4 c Long Grain Rice, Uncooked**  
**8 ts Instant Chicken Bouillon**  
**2 ts Salt**

**4 ts Dill Weed Or Dill Seed**  
**5 ts Dried Grated Lemon Peel**

1. Combine all ingredients in a large bowl and blend well.
2. Put 1-1/2 cups of mix into 3 1-pint airtight containers and label. Store in a cool, dry place and use within 6 to 8 months.

Makes about 4-1/2 cups of mix.

*DILL-LEMON RICE:*

Combine 1-1/2 cups of mix, 2 cups cold water, and 1 Tb butter or margarine in a medium saucepan. Bring to a boil over high heat; cover and reduce heat. Cook for 15 to 25 minutes until liquid is absorbed. Add meat as desired. Makes 4 to 6 servings.

*Onion-Flavored Rice Mix*

Servings: 12

**4 c Uncooked Long Grain Rice**  
**2 pk Onion Soup Mix (1 1/4 oz)**

**1 Tb Parsley Flakes**  
**1 ts Salt**

1. Combine ingredients in a large bowl; stir until well blended.
2. Put 1-1/3 cups of mix into 3 1-pint airtight containers and label. Store in a cool, dry place and use within 6 to 8 months.

Makes about 4 cups of mix

*ONION-FLAVORED RICE:*

Combine 1-1/3 cups rice Mix, 2 cups cold water, and 1 Tb butter or margarine in a medium saucepan. Bring to a boil over high heat; cover and reduce heat. Cook for 15 to 25 minutes, until liquid is absorbed. Add meat as desired. Makes 4 to 6 servings

*Vegetarian Rice Mix*

Servings: 12

- |   |                               |
|---|-------------------------------|
| <b>4 c Raw Long-grained Rice</b>        | <b>2 ts Salt</b>              |
| <b>4 ts Onion Flakes</b>                | <b>4 ts Red Pepper Flakes</b> |
| <b>3 Tb Instant Vegetarian Bouillon</b> | <b>4 ts Celery Flakes</b>     |
| <b>4 ts Green Pepper Flakes</b>         |                               |

1. Combine all ingredients in a large bowl; stir until well blended.
2. Put about 1-1/2 cups of mix into three 1-pint airtight containers and label. Store in a cool, dry place and use within 6 to 8 months.

Makes about 4 1/2 cups of mix.

*VEGETARIAN RICE:*

Combine 1 1/2 cups mix, 2 cups cold water, and 1 Tbs. butter or margarine in a medium saucepan. Bring to a boil over high heat; reduce heat and cover. Cook for 15 to 25 minutes, until all liquid is absorbed. Makes 4 to 6 servings.

*Chili Mac*

*Mac Kool*

*ONEPOT*

- |                              |                          |                    |
|------------------------------|--------------------------|--------------------|
| <b>1/2 cup dried beef</b>    | <b>1 1/2 tsp. salt,</b>  |                    |
| <b>1/4 tsp. black pepper</b> | <b>2 T. chili powder</b> | <b>3 cup water</b> |

Bring to boil. Add 1 1/2 cups noodles and simmer 15 min. When done, stir in 1/3 cup powder milk and 4 T. margarine. Top with parmesan cheese or cheddar.

*Beef Stroganoff*

*version 1*

*TWOPOT*

- |                           |                           |                    |                     |
|---------------------------|---------------------------|--------------------|---------------------|
| <b>2 cups egg noodles</b> | <b>1/2 cup dried beef</b> | <b>2 tsp. salt</b> | <b>3 cups water</b> |
|---------------------------|---------------------------|--------------------|---------------------|
- boil and simmer 15 minutes, Stir in sauce and 4 T. margarine.

- |                            |                              |                               |
|----------------------------|------------------------------|-------------------------------|
| <b>2/3 cup powder milk</b> | <b>1 pkg. sour cream mix</b> | <b>1 pkg. stroganoff mix,</b> |
|----------------------------|------------------------------|-------------------------------|
- mix above with 1 1/2 cup water and simmer

*Beef Stroganoff*

*version 2*

*ONEPOT*

- |                             |                                     |
|-----------------------------|-------------------------------------|
| <b>1 package dried beef</b> | <b>1 small can sliced mushrooms</b> |
| <b>2 T. dried onions</b>    | <b>2 T. oil</b>                     |
| <b>1 cup beef bouillon</b>  | <b>1 T. Worcestershire sauce</b>    |

**1/2 teas. paprika**  
**1 1/2 cup Minute Rice**

**sour cream mix**  
**tomato soup mix**

Mix all but the rice and bring to full boil. Add rice and cover and stand 5 minutes.

*"It's in the bag" Chinese*                      *Dennis A. Schmitt T928*                      **ONEPOT**

**1 can Chinese vegetables,**  
**1 can Chinese noodles**  
**1.5 cups Minute Rice**

**1 can bean sprouts,**  
**2 @ 4 oz cans of cooked chicken.**  
**Soy Sauce**

Place rice in a large **2 qt. heavy freezer style zip lock bag**. Boil 1.5 cups of water and place in bag with rice, add Chinese vegetables, sprouts and chicken. Seal and let set 5 minutes. Serve over Chinese noodles and season with Soy Sauce.  
 No pot to clean... **serves 4-5**

*Koosah (Sky) Mountain Stew*                      This recipe was taken from "The Well-Fed Backpacker" by June Flemming, 1986.                      **ONEPOT**

Try the basic recipe first, or put together variations that are cheaper, lighter or quicker to suit the needs of your particular journey.

**At home: pack in a 1-quart zipper bag**

**1 packet sour cream sauce mix, 1/4 cup instant dry milk,**  
**1/4 cup grated parmesan cheese, 1/4 tsp paprika.**

**Also pack: 1 lg clean but unpeeled potato one small can turkey, one 2 serving pack of freeze dried green beans or 2 handfuls fresh green beans.**

In camp:

Cut the clean, unpeeled potato into small dice and cook it and the green beans for about 8 minutes in 2 1/2 cups boiling water. While this simmer, add 1/2 cup cold water to sourcream bag, seal and knead until well mixed. In the can, cut the turkey into bite sized pieces. When the veggies are tender, add the sauce mix and meat, stir well and heat through.

Ramen noodles can be substituted for potatoes to cut cooking time.

*Potato Soup*

**ONEPOT**

**1 cup potato buds  
2 beef bouillon**

**1/2 cup dry milk,  
dried parsley and onions.**

Boil 4 cups water, mix, bring back to boil and simmer couple of minutes.

*Chicken Stew with Dumplings*

**ONEPOT**

Servings: 6

**3 pk Chicken Noodle Soup envelopes  
4 Tb Flour**

**3 cn Chicken, boned 12/14 oz  
9 c Water**

Dumplings

1. Put the soup mix and flour into a large kettle.
2. Stir in water and add the boned chicken.
3. Place on the fire and bring to a boil, stirring occasionally.
4. Make dumplings. See the Dumpling recipe for directions.

*Brown Rice and Shrimp*

**ONEPOT**

Servings: 2

**2 c Brown Rice**

**1 cn Shrimp, 6 1/2-oz**

**1 c Freeze-dried String Beans**

**1/2 ts Salt**

**1/8 ts Thyme**

**5 c Water**

**or 1/2 c Freeze-dried Shrimp**

**1 Tb Onion Flakes**

**1/8 ts Oregano**

**1 Tb Oil**

1. To boiling water and oil add rice, salt, and onion. High simmer for 30 to 45 minutes.
2. During the last few minutes add string beans and shrimp.

Variations

- a. Dried shrimp and dehydrated string beans may be used instead--add them halfway through cooking.

*Alpine Spaghetti*

**ONEPOT**

Servings: 2

<b>8 oz Spaghetti or Noodles</b>	<b>1 Tb Olive Oil</b>
<b>1 c Parmesan Cheese</b>	<b>3 ts Ground Sweet Basil</b>
<b>1 Tb Parsley Flakes</b>	<b>1 Garlic clove, minced</b>
<b>Water</b>	

1. Bring a pot of water to boil and add spaghetti. Boil for 10 minutes and drain.
2. Add olive oil, toss, then add rest of ingredients and toss again until thoroughly mixed.

*Chili*

**ONEPOT**

Servings: 2

<b>1 c Lentils</b>	<b>3 Tb Tomato Powder (optional)</b>
<b>2 Tb Masa or Corn Flour (optional)</b>	<b>1 Tb Chili Powder</b>
<b>1 Tb Onion Flakes</b>	<b>1 ts Cumin</b>
<b>1 ts Oregano</b>	<b>1 ts Salt</b>
<b>1 Clove Garlic</b>	<b>4 c Water</b>

1. Combine all ingredients and simmer 30 to 45 minutes depending on altitude.
2. Put some cheese in your bowl and pour on some chili. Good with cornbread cakes on a cold night.

*Pinto Beans*

**ONEPOT**

Servings: 2

<b>1 c Pinto Beans, cracked in a loose-set grain grinder</b>	
<b>1 ts Cumin</b>	<b>1/2 ts Salt</b>
<b>1 Garlic Clove, minced</b>	<b>1 pn Cayenne Pepper</b>
<b>1 Tb Oil</b>	<b>4 c Water</b>

1. Beans should be cracked about the size of split peas.
2. Add all ingredients to boiling water and oil and simmer 30 minutes.
3. Serve with Corn Pancakes and cheese.

Variations

- a. Add 1 teaspoon chili powder.

*Spinach Cheese Casserole*

**ONEPOT**

Servings: 2

**1 1/4 c Brown Rice** **1/2 c Dehydrated Spinach Flakes**  
**1/4 c Dried Mushrooms, sliced thin, chopped fine** **1 Garlic Clove, minced**  
**1/2 ts Salt**  
**1 cn Shrimp, 6 1/2-ounce can,** **or 1 c Dried Shrimp, or 1/2 c Freeze-dried Shrimp**  
**1/2 lb Cheddar Cheese, grated or chopped in small chunks**  
**1 ts Oil** **3 c Water**

1. Combine all ingredients except cheese and shrimp, if you use canned or freeze-dried.
2. Bring to boil and simmer 45 to 60 minutes. Stir in cheese and canned or freeze-dried shrimp (unless you used dried).
3. Cover for 2 to 3 minutes, then serve hot.

*Asian Rice and Lentils***ONEPOT**

Servings: 2

**1/2 c Brown Rice** **1/2 c Lentils**  
**2 Tb Butter** **1 Onion, chopped, or 1 Tb Onion Flakes**  
**1/2 ts Salt** **1/2 ts Cinnamon**  
**1/2 ts Ginger** **1/2 ts Cardamon**  
**2 Whole Cloves** **1 Bay Leaf**  
**1 pn Cayenne Pepper (optional)** **2 1/2 c Water**

Rice and lentils, when eaten together, make a richer balance of protein than if they are eaten separately.

1. Melt butter in cook-pot and add all dry ingredients. Saute a few minutes and then cover with water.
2. Cover pot, place over low heat, and cook 45 to 60 minutes. To reduce cooking time in camp, try cracking rice and lentils in loosely set grain grinder at home.

*Corn Chowder***ONEPOT**

Servings: 2

**1/2 c Dehydrated Corn** **4 1/4 c Water**  
**1/2 c freeze-dried Potatoes** **or 1 Potato, raw, unpeeled, cut in small pieces**  
**2 Tb Corn Meal** **2 Tb Whole Wheat Flour**  
**2 Tb Soy Milk Powder** **1 ts Parsley Flakes**  
**1 ts Onion Flakes** **1 ts Celery Flakes**  
**1/2 ts Salt** **1/8 ts Paprika**  
**ds Pepper** **1 Tb Butter**

**1 cn Cracked Crab w/juice, 6 1/2-oz (optional)**

A thick, creamy chowder, high in protein and a special treat with added crab.

1. Combine all dry ingredients in one bag before you go.
2. In camp combine all ingredients, except crab, in cold water and stir well.
3. Bring to boil, stirring occasionally. Simmer for 10 to 15 minutes.
4. Add can of crab and its juice, if desired, and heat through. Serve hot.

*Lentil Soup*

Servings: 2

<b>1/2 c Lentils</b>	<b>1 ts Dried Carrot Flakes</b>
<b>1 ts Dried Minced Onion</b>	<b>1/2 ts Salt</b>
<b>1/4 c Potato Buds</b>	<b>1 ts Butter or Margarine</b>
<b>3 c Water</b>	<b>2 Tb Parmesan Cheese (opt.)</b>

Dumplings, optional

1. Add 3 cups water to the lentil mix in a pot. Cover and bring to a boil; then take the pot off the heat to sit for 15 min.
2. Boil again, simmer for 15 min. Add potato buds and cook a few more minutes. Add 1 tsp. butter or margarine or cut some parmesan cheese into the soup.
3. Add dumplings if desired. See Dumplings recipe.

*Polenta Cheese Soup***ONEPOT**

Servings: 2

<b>1/2 c Dehydrated Corn</b>	<b>1/4 c Polenta</b>
<b>1 Tb Dehydrated Bell Pepper</b>	<b>1 Bay Leaf</b>
<b>1 ts Parsley Flakes</b>	<b>1 ts Onion Flakes</b>
<b>1 ts Celery Flakes</b>	<b>1/2 ts Salt</b>
<b>1/8 ts Savory</b>	<b>ds Cayenne Pepper</b>
<b>1 ts Oil</b>	<b>4 c Water</b>
<b>1/2 c Milk Powder</b>	<b>1/4 lb Cheddar Cheese</b>
<b>1/4 c Sunflower Seeds (optional)</b>	

1. Combine all ingredients, except cheese, milk powder, and seeds, with oil and 3 cups of water. Bring to boil and simmer for 15 minutes.
2. Mix milk powder and remaining 1 cup water. Combine with polenta when it is cooked.
3. Grate in cheddar cheese or cut in small chunks and stir in. Sprinkle with sunflower seeds if desired.

*Lentil Tomato Soup*

**ONEPOT**

Servings: 2

- |   |  |
|---|--|
| <b>2/3 c Lentils</b>                    | <b>1/2 c Noodles, whole wheat, soy-rice, or sesame</b> |
| <b>1/4 c Freeze-dried Tomato Powder</b> | <b>1 Tb Vegetable-seasoned Broth Powder</b>            |
| <b>2 ts Parsley Flakes</b>              | <b>1 ts Salt</b>                                       |
| <b>1/4 ts Garlic Granules</b>           | <b>ds Pepper</b>                                       |
| <b>1 Tb Oil</b>                         | <b>5 c Water</b>                                       |

1. Add all ingredients to boiling water and oil and cook at a low boil for 30 to 40 minutes.

*Clam Chowder*

**ONEPOT**

- |                              |                              |   |
|------------------------------|------------------------------|---|
| <b>2 cups dried potatoes</b> | <b>3 cups water</b>          | > can use hash browns                           |
| <b>1 T. dried onions</b>     | <b>parsley</b>               | >cook potatoes, et etc., about 10 min.          |
| <b>1 cup dried milk</b>      | <b>2 T. margarine</b>        | >add the rest, stir and heat, <b>don't boil</b> |
| <b>2 T. crumbled bacon.</b>  | <b>8 oz can minced clams</b> | >add more water if needed.                      |

*Agua Caliente*

*Phil Monte*

**ONEPOT**

- |                    |                    |
|--------------------|--------------------|
| <b>32 oz water</b> | <b>1 large pot</b> |
|--------------------|--------------------|

Carefully measure the water and place in the pot. Add your metal cups and spoons. Cover and place on stove. Lite the fire and bring water to a boil for 3 minutes. Remove utensils, placing them on a clean surface. Use the hot water for coffee or preparing food. Use leftover water for cleaning.

*White Sauce*

- At Home: 2 Tbsp. dry milk, 1 Tbsp. Butter Buds, 1 1/2 Tbsp. flour, pinch salt into a bag.**  
**At Camp: >mix mixture and 1 cup water 1 1/2 Tbsp. butter or margaine**

melt butter and cook the mixture slowly 1-2 minutes, low heat. Stir until thick 4-5 minutes. Add spices or cheese for a sauce over rice or noodles,

*Chunky Beef Over Rice*

*Campbell*

**ONEPOT**

**1 can Campbell's Chunky Beef Soup**  
**1 cup broccoli flowerets cooked**  
**1 T vegetable oil**

**2 tbs. Worcestershire Sauce**  
**1 pkg. Success Rice, cooked**

In saucepan, combine soup, broccoli and Worcestershire sauce. Over medium heat, heat through, stirring often. Serve over rice. Yield: 2 servings

*Cous - Cous Cluck - Cluck*

**ONEPOT**

**1 cup Cous-Cous**  
**chicken bouillon cube**

**4 oz. canned chicken**  
**water**

Boil the water with the Cous-Cous and bouillon cube. Use enough water to cover the Cous-cous. add the chicken after you have removed it from the can. Add seasonings.

*Paramecium Alfredo*

*Dick Ross*

**ONEPOT**

**Lipton Alfredo Noodle mix**  
**broccoli**

**dry milk**  
**butter**

**1 can chicken 4 oz**  
**parmesan cheese (parameciums)**

1/2 package Alfredo noodle mix, (with 2-3 Tablespoons dry milk and some extra parmesan cheese mixed in) 1 can 4 oz. chicken meat, fresh broccoli, butter. This all goes in one pot and cooks together. Add a Hard Roll.

*Instant Refried Beans*

*Fantastic Foods*

**1 1/2 cups instant refried beans**  
**1 Tbl. butter**

**2 cups water**  
**cheese**

Boil water and add to beans in a bowl. Stir well, cover 5 minutes - ready to serve. Variations include adding butter and cheese. Use in Frijoles Dip with salsa and Monterey Jack cheese. Use on Nachos, Tostadas, or in Bean Burritos.

*I can Ham, and you can two*

*Dick Ross*

**ONEPOT**

**"I" can ham 4 oz**  
**dried mushrooms**

**Lipton Alfredo Noodle mix**  
**butter**

**dry milk**  
**parmesan cheese**

1/2 package Alfredo noodle mix (left over from yesterday), (with 2-3 Tablespoons dry milk and some extra parmesan cheese mixed in), "I" can ham (4 oz.), dried mushrooms, butter. Hard Roll. Cook in that pot from yesterday.

*Cimarroncito Carbonara*

*Philmont*

**ONEPOT**

**2 1/4 cups elbow macaroni  
1/4 cup dried vegetable mix  
5 cups water**

**1 pkg. white sauce mix  
salt & pepper to taste  
1/4 cup bacon bits**

**1/4 cup powder milk**

Place the bacon bits in a separate plastic bag and all the other dry items in a larger plastic bag. In a large pot place the dry mixture and water. Mix well and bring to boil. Cover and simmer until macaroni is done. Add the bacon bits before serving or as a topping.

*Quick Rice*

*Minute Rice*

**Bag**

**1/2 cup Minute rice**

Place 1/2 cup Minute rice in a heavy freezer zip lock bag, add 1/2 cup boiling water to bag, Wait 3 minutes. Makes 1 serving 3/4 cup cooked. Add butter buds and salt. Multiply recipe by # of serve.

**No pot No mess**

*Cheeseburger Rice*

*Minute Rice*

**ONEPOT**

**1 lb. ground beef  
1/2 cup catsup  
1/2 tsp. pepper**

**1 sm. onion, chopped  
2 T. mustard  
1 1/2 cups Minute rice**

**1 1/2 cups water  
1/2 tsp. salt  
1 cup shredded cheese**

Brown meat and onions, drain fat. Stir in water, catsup, mustard, salt & pepper. Bring to boil. Stir in rice, cover. Remove from heat and let stand 5 minutes. fluff with fork and sprinkle with cheese; cover. Let stand 3 minutes or until cheese melts. serves 4

*Zastrow-roni*

*Philmont*

**ONEPOT**

**2 1/4 cups elbow macaroni  
1/4 cup dried vegetable mix  
5 cups water**

**1 pkg. taco sauce mix  
salt & cayenne pepper to taste  
1/2 cup grated Parmesan cheese**

**1/4 cup powder milk**

Place the cheese in a separate plastic bag and all the other dry items in a larger plastic bag. In a large pot place the dry mixture and water. Mix well and bring to boil. Cover and simmer until macaroni is done. Add the Parmesan before serving or as a topping.

*Lemon Butter Potatoes -Ann Criswell Houston Chronicle*

This recipe shows off new red potatoes at their best. Since we started using it in the '70s, we have seldom prepared new potatoes any other way.

**3 pounds small red potatoes  
3 slices lemon  
Boiling water**

**1 medium-size onion, sliced  
1 teaspoon salt  
1/4 cup margarine, melted**

**1 tablespoon fresh lemon juice**

Wash unpeeled potatoes; put in 3-quart saucepan with onion, lemon slices and salt. Cover with boiling water and cook over medium-high heat until tender; drain. In a small saucepan over medium-low heat, whisk together margarine and lemon juice. When ready to serve, remove lemon slices from potatoes and pour hot lemon butter sauce over potatoes. Makes 6 servings.

*Sloppy Joe Seasoning Mix*

- |                                     |                            |
|-------------------------------------|----------------------------|
| <b>1 tb Instant Minced Onion</b>    | <b>1 ts Salt</b>           |
| <b>1/2 ts Instant Minced Garlic</b> | <b>1/4 ts Celery Seed</b>  |
| <b>1 ts Green Pepper Flakes</b>     | <b>1 ts Cornstarch</b>     |
| <b>1/4 ts Dry Mustard</b>           | <b>1/4 ts Chili Powder</b> |

Combine all ingredients in a small bowl until well blended. Spoon mixture onto a 6-inch square of aluminum foil and fold to make airtight. Label as Sloppy Joe Seasoning Mix. Store in a cool, dry place and use within 6 months.

Makes 1 package (about 3 T) of mix.

***Sloppy Joes:*** Brown 1 lb lean ground beef in a medium skillet over medium-high heat. Drain excess grease. Add seasoning mix, 1/2 cup water, 1 (8 oz) can of tomato sauce and bring to a boil. Reduce heat and simmer 10 minutes, stirring occasionally. Serve over toasted hamburger buns. Makes 6 servings

*Skillet Fajitas Supremas*

- 3/4 pound well-trimmed pork tenderloin or chicken breast**
- Picante sauce**
- |   |   |
|---|---|
| <b>1 tablespoon flour</b>   | <b>1 1/4 teaspoons ground cumin (comino)</b>          |
| <b>1 teaspoon vegetable oil</b>   | <b>2 garlic cloves, minced</b>                        |
| <b>1 cup slivered onion</b>   | <b>8 (7-inch) reduced-fat flour tortillas, heated</b> |
| <b>1 cup each, cut in short, thin strips: green and red bell peppers</b>            |   |
| <b>Sour cream, thin tomato wedges and chopped cilantro, for toppings (optional)</b> |   |

Cut meat into short, thin strips; set aside. In a small bowl, combine 1 cup picante sauce, flour and cumin. Heat oil in a 10-inch nonstick skillet over medium heat. Add onion and bell peppers; cook and stir 2 minutes. Add meat and garlic; cook, stirring frequently, 4 to 5 minutes, or until meat is cooked through.

Stir in picante sauce mixture; cook, stirring, 1 minute, or until sauce thickens. Spoon about 1/3 cup mixture down center of each tortilla; top as desired. Roll up and serve with additional picante sauce. Makes 4 servings.

*Cowboy Steak 'n' Veggie Soup*

*Linda Morten of Katy*

**1 (16-ounce) bag frozen mixed green beans, potatoes, onions and red bell peppers**  
**1 (1-pound) boneless beef sirloin steak (1 inch thick)**  
**1/4 teaspoon freshly ground black pepper**                      **1 teaspoon dried basil leaves**  
**2 (14.5-ounce) cans ready-to-serve beef broth**              **1/2 teaspoon salt**  
**1 (16-ounce) jar mild chunky-style salsa**                      **1 tablespoon oil 2 garlic cloves, minced**  
**1 (15.5-ounce) can great Northern beans, drained and rinsed**  
**1 cup torn fresh spinach**  
**Chopped fresh basil, parsley or cilantro for garnish**

Boil bag of frozen vegetables (without the bag) on high 8 minutes, or until vegetables are tender; set aside.

Cut beef into 1/4-inch-thick strips; cut each strip into 1-inch pieces. Place beef in a 4-quart Dutch oven; add oil, garlic, basil, salt and pepper; toss to coat. Cover with lid. Stirring midway through cooking, 10-15 minutes, or until meat is barely pink.

Add broth, salsa, beans and cooked vegetables. Cover and heat on high 8 to 10 minutes, or until steaming hot. Stir in spinach and garnish with fresh basil.

Makes 6 (1½-cup) servings, each: 260 calories, 24 grams protein, 8 grams fat (17 percent of calories), 23 grams carbohydrates, 5 grams dietary fiber, 50 milligrams cholesterol, 1,140 milligrams sodium.



## Cooking with Coals..

Coals are produced in two ways. Charcoal comes in bags not suited for backpacking but great for car camping. Place the Bag in a 5 gal. bucket to keep dry. The other method is producing coals from a wood fire. Hardwoods make better coals than softwoods such as pine. Twigs do not produce coals very well, if at all. 1 1/2 - 2 inch thick limbs make better coals. They are small enough to burn down, and large enough to make coals. The cooking can be done directly on the coals using foil wrapped food or Dutch Oven, or use a grate over the

coals. The temperature can be determined by holding the back of your hand over the coals. Allow 30-40 minutes to get the coals ready before cooking.

Approximate Temperature	Type of Fire	8" cast iron 12" coals				Seconds over fire
		Under / Top		Under / Top		
250-325 degrees	slow	2	4	3	5	6-8
325-400	Medium	3	5	4	6	4-5
400-500	Hot	4	6	5	7	2-3
> 500	Very Hot	5	7	6	8	1

All dutch oven cooking is done by hot coals, never in a flaming fire. The coals may be from hardwoods like oak and hickory or from charcoal. Hardwoods yield long-burning coals which are necessary for the lengthy cooking process in most dutch oven recipes. Soft woods like pine are unsatisfactory.

Charcoal is more convenient to use and is necessary in areas where there is no downed hardwood. Use a firepan under the coals to prevent killing ground cover. The firepan can be metal or plywood with a thick layer of mineral soil (sand). Three or four stones can be used to prop up the pan above the ground.

The amount of charcoal needed will vary with the weather (wind and temperature)

### Cooking with Cast Iron

Cooking with cast iron can be a lot of fun, whether you use an old dutch oven for cooking over a campfire or making gems using your great grandmother's pan. There are several things to remember, however:

- \* Cast iron is brittle. Try not to drop it; it could crack the iron, not to mention break your foot.
- \* The cast iron gods always seem to require the sacrifice of your first born--in other words, the first thing you cook in your newly reseasoned pan will be scorched beyond recognition to appease the spirits! Don't feel badly...it has happened to all of us.

\* Use a no-stick spray when you cook. Some foods, such as gems or waffles, come out of the pan a lot easier when the pan is prepared with no-stick spray. Using just vegetable shortening, until the pan is really seasoned, tends to result in a mess.

\* Don't overheat a pan on a stove. Many skillets were warped because they were cooked over heat that was too high.

\* Avoid cooking foods with a high acid content (e.g., tomatoes) in the pan. I'm told it can pit the inside of the pot or skillet (which would explain all of the skillets and dutch ovens I've seen that are pitted on the inside and perfect on the outside).

Never put cold liquids or solids ( frozen hamburger comes to mind ) into a hot Dutch oven. The oven can crack from thermal contraction.

*Turkey and Stuffing Pie*



***DUTCH OVEN***

Categories: Dinner, Dutch oven  
Yield: 6

- |                                  |                                    |               |
|----------------------------------|------------------------------------|---------------|
| <b>2 cup prepared stuffing</b>   | <b>1 cup shredded swiss cheese</b> |               |
| <b>2 can chunk turkey (5 oz)</b> | <b>1/2 cup milk</b>                | <b>3 eggs</b> |

Preheat dutch oven. Pat stuffing evenly into 9-inch pie plate to form crust. Building up sides to form rim. Sprinkle turkey and cheese evenly over stuffing. In small bowl, beat together milk and eggs; pour over turkey. Bake 35 to 40 minutes or until knife inserted near center comes out clean. Let stand 5 minutes before serving.

*Guadeloupe Chili Pie*

***DUTCH OVEN***

- |                                |                                     |
|--------------------------------|-------------------------------------|
| <b>2 lb. ground beef</b>       | <b>1/2 tsp. chili powder</b>        |
| <b>1 med. onion, sliced</b>    | <b>1/2 tsp. salt</b>                |
| <b>1 tbs. margarine</b>        | <b>1 8-oz can tomato sauce</b>      |
| <b>1 15-oz can chili beans</b> | <b>1 6-oz package cornbread mix</b> |

Brown beef and onions in the margarine in open Dutch oven. Add beans, chili powder, salt, and sauce; cook for 15 minutes in covered oven.

Mix the cornbread as directed and add to top of meat and beans. Place lid on oven, Cook for 20-30 minutes, until cornbread is done. **Serves 8 persons.**

*Frito Pie(6)*

*Troop 421*

***Dutch Oven Style***

- |   |                      |
|---|----------------------|
| <b>1 - 24 oz can chili</b>                  | <b>1 can tamales</b> |
| <b>1/4 cup tomato sauce</b>                 | <b>6 cups Fritos</b> |
| <b>american cheese (sliced or shredded)</b> |                      |

Line dutch oven with foil: coat with cooking spray. Place tamales on bottom, then place chili and Fritos in layers. Cook for 45 minutes. Place cheese ont top 5 minutes before meal is done.

*Beef Pot Roast with Vegetables (6) Troop 421*

*Dutch Oven Cooking*

- 1 (4 lb) chuck roast**
- 1 pkg baby carrots**
- 2 medium onions**
- 4 medium peeled potatoes**
- salt, pepper, and seasoning to taste**

Cover roast with seasoning blend and place in Dutch oven. Quarter the potatoes and add to roast along with carrots. Fill Dutch oven with 2 inches of water and cook for 3 hours or until tender. Quarter onions and add after 1 1/2 hours. serves 6.

*Lasagna Pie*

*Dutch Oven Cooking*

- 1/2 cup creamed cottage cheese**
- 1 lb. Ground beef**
- 1 cup shredded Mozzarella cheese**
- 1/2 tsp. Salt**
- 1/2 tsp. Dried oregano**
- 1 can (6 oz) tomato paste**
- 1 cup milk**
- 1/2 cup Bisquick Baking mix**
- 2 eggs**

Grease a 9” dutch oven and line with aluminum foil. Spread the cottage cheese in the bottom of the dutch oven. In a separate pan cook the ground beef and drain the grease. Stir in 1/2 cup mozzarella cheese, salt, oregano, and tomato paste; Then spoon over cottage cheese. In a bowl or heavy plastic bag stir the milk, Bisquick, and eggs until well blended. Pour into dutch oven. Bake for 30-35 min. or until knife inserted in the center comes out clean. Sprinkle with remaining cheese. And Bake 1-2 min. to melt cheese. **8 servings**

*Dutch Oven Pizza*

*Troop 421*

*Dutch Oven Cooking*

- canned biscuits**
- grated mozzarella cheese**
- pizza fix’ins- pepperonit, sausage, mushrooms, onion, green peppers, etc**
- pizza or spaghetti sauce**
- cooking spray**

Line Dutch oven with the foil making sure there are no air pockets. Cover with cooking spray. Make the pizza crust by pressing biscuits into bottom of Dutch oven. Spoon sauce over crust and top with desires fix’ins and cheese. Cook 10-15 minutes or until done. Check often to prevent burning.

*Pizza Hot Dish*

*Dutch Oven Cooking*

- 2 pk Crescent rolls**
- 1 1/2 lb Ground Beef**
- 8 oz Shredded Mozzarella Cheese**
- 1 Jar Pizza Sauce**
- 8 oz Shredded Cheddar Cheese**

Brown ground beef, drain. Line dutch oven with 1 pkg of crescent rolls. Spread pizza sauce on dough. Add browned beef, the cheeses and use second pkg of rolls to form a top crust. Bake 30 min. at 350.

*Campers Pizza Pie**Pie Irons*

**1 lb Wheat bread  
pizza or spaghetti sauce**

**1/4 lb Mozzarella cheese  
8 oz .Pepperoni**

**DIRECTIONS** Using the pie iron,take two slices of bread,put 1 1/2 tablespoons pizza sauce on one slice of bread.Top with Mozzarella cheese and sliced pepperoni.Place other side of bread on top and butter outer sides of bread.Put sandwich into pie iron and place in coals of fire.Cook until bread is toasted.

*Chicken and Stuffing Bake**Kroger****DUTCH OVEN***

**4 cups Pepperidge Farm Herb Seasoned Stuffing  
6 Skinless Boneless chicken breast halves  
1 can Campbell's Cream of Mushroom soup**

**Paprika margarine  
1/3 cup milk  
1 tbs. Chopped parsley**

Mix stuffing with 1 cup boiling water and 1 tbs. Margarine. Spoon the stuffing across the center of 4 qt. Dutch oven. Place the chicken on each side of stuffing. Sprinkle the chicken with paprika. Mix soup, milk and parsley and pour over the chicken. Bake at 400 degree heat for 20 minutes and then open top a bit and bake additional 10 minutes. Serves 6.

*Flank Steak Supreme (4)**Trrop 421****Dutch Oven***

**1 Flank steak Onion and seasoning to taste  
1 can Mushroom steak sauce**

Heat Dutch oven prior to preparation. Place steak on 12x24 inch piece of foil. Season with onion salt. spread mushroom sauce over steak. Wrape in foil and seal. Place in Dutch oven for 1 hour and 30 minutes.. serves 4

*6 to 8 Pork Chops and Rice**Troop 421****Dutch Oven***

**6 to 8 pork chops  
6 to 8 tbsp. rice  
6 to 8 slices onion  
6 to 8 slices tomato  
6 to 8 slice bell pepper  
1 can chicken broth**

Brown the pork chops on both sides. Line dutch oven with foil and cover foil with cooking spray. Place 1 tbsp rice for each pork chop on the bottom. Place pork chops on rice. Place slice of onion, tomato, and pepper on each chop. Cover with chicken broth and cook for 1 hour. Feeds 6 to 8.

*Corn Casserole*

*Kelly Hall*

*Dutch Oven*

**1 can creamed corn**  
**1 stick melted margarine**  
**1 (8 oz) carton sour cream**

**1 can whole kernel corn**  
**1 (6 oz) package cornbread mix**

Mix all ingredients together. Bake at 350 degrees for 30 minutes. serve with crackers.

*Chili Pie*

*Hormel*

*DUTCH OVEN*

**4 cups corn chips**                      **1 @ 19 oz can Name brand Chili**  
**2/3 cup chopped onion**              **1 1/2 cups shredded Colby or Cheddar cheese**

Layer 2 1/2 cups of corn chips; onion; 1/2 cup cheese and chili in 1 1/2 quart casserole or Dutch oven. Top with remaining corn chips. Bake at (375) about 25 minutes. Top with remaining cheese and bake 5 minutes longer. Garnish with sour cream and ripe olives, etc.  
**Serves 4-5** or one scoutmaster

*Chili Rice Casserole*

*Hormel*

*DUTCH OVEN*

**3 cups cooked rice**                                      **1 (19 oz) can plain chili**  
**1/2 cup onions, chopped**                              **3/4 cup crushed corn chips**  
**4 oz cheddar cheese, shredded**

Place rice in buttered baking dish or Dutch oven. Spread half the onions and crushed corn chips over the rice. Heat chili and pour over rice. Top with remaining cheese, onions and crushed corn chips. Heat in at ~375 for 25 minutes. **Serves 4-6.**

*Goulash*

*A Bate's*

**1 lb of hamburger**  
**a couple of potatoes**  
**a couple of onions**  
**carrots if you have them**  
**other veggies if available**  
**ketchup or other tomato type sauce**  
**about 1 cup of water**

Directions: Brown the beef and drain. Cut up the potatoes, onions and carrots and add to the browned beef. Add water and let simmer covered for about an hour. Stir about every 10 minutes. During the last 15 or 20 minutes add about 3/4 of a cup of the sauce, stir and cover again. This goulash is done when the potatoes are soft. This is really very good and we know you'll enjoy it. serves 4

*Gail's Chicken Enchiladas*

***DUTCH OVEN***

- 4 boneless butterfly chicken breasts - boil and shred**
- 1 onion chopped**
- 16 oz. sour cream**
- 1 small can chopped green chilies**
- 1 pkg. 4-cheese blend Mexican cheese**

Directions: Mix all that in a bowl. Spoon into small soft flour tortillo shells (2 pkgs. of 10 each). Roll up and place in 2-9 x 13 greased pans. Cover each pan with 1 jar of taco sauce and 1/2 pkg. of shredded cheddar cheese. Bake 350 for 30 minutes. Makes 8-10 servings. You can also substitute 3 lbs. of ground beef for the chicken.

*Kit Carson Pie*

*Philmont*

***DUTCH OVEN***

- |   |  |
|---|--|
| <b>2 lb. lean ground beef</b>             | <b>1 onion</b>                         |
| <b>2 6 oz. cans tomatoe paste</b>         | <b>2 cups water</b>                    |
| <b>1 16 oz. pkg refrigerator biscuits</b> | <b>2 pkg. sloppy joe seasoning mix</b> |

Brown the beef and onion. add seasoning mix, tomatoe paste and water. Stir and bring to boil. Place the biscuits over the mixture and bake for 15-20 minutes or until biscuits are brown. **Serves 4-6** or one scoutmaster

*Easy Potato Soup*

*Bank of Winnfield, Winnfield, LA*

***Dutch Oven***

- |   |  |
|---|--|
| <b>1 (16 oz) bag frozen hash browns</b> | <b>1 (10 3/4 oz) Cream of Celery Soup</b>  |
| <b>1 cup chopped onion</b>              | <b>1 (10 3/4 oz) Cream of Chicken Soup</b> |
| <b>1 (14 oz) can chicken broth</b>      | <b>2 cups milk</b>                         |
| <b>3 cups water</b>                     | <b>Salt and Pepper to taste</b>            |

Combine frozen hash browns, onion, chicken broth and water in dutch oven and simmer 30 minutes. Use less water for thicker soup. Stir in undiluted soups, milk, salt and pepper. Heat thoroughly. Serves 10-12.

## Dinner Items: Foil Meals

Hot meals are great but who wants to wash dishes. Try these **Foil meal ideas** or try a seal-a-meal or freezer zip bag in boiling water .

### **Drugstore wrap:** *Not Drug Rap..*

1. Cut 2 pieces of lightweight foil or 1 piece of heavy-duty foil, twice the circumference of the item to be wrapped.
2. Place food in middle of foil, shiny side in. Food must be moist or add 4 Tbl. of fluid.
3. Bring opposite sides of foil together, and fold 1/2 inch, repeat turning down to item.
4. Flatten top of package, Fold corners of open ends in and roll ends in small folds into center. The edges must seal to keep steam in.

### *Boy Scout Potatoes*

*B. Powell?*

**FOIL**

**Potato**

**Carrot**

**Small onion**

**Salt & Pepper**

**margarine**

Slice the Potato into 1/4 inch slices. Peel and slice the onion and carrot. Place in the middle of a drugstore foil wrap with salt, pepper, & a dollop of margarine. Add 1 Tbls. water. Seal the Wrap and place on coals for 45 minutes to a hour.

### *Baked Apple*

**FOIL**

**1 apple per person, 1 tablespoon brown or white sugar per apple  
optional rasins and red hots.**

Wash apple. Cut a slice off the top, remove the core, and put the sugar in the hollow. Wrap in foil. Cook in hot ashes about 1 hour.

### *Mountain Melts*

**FOIL**

**Rolls (any kind)**

**Meat (thinly sliced)**

**Cheese (sliced)**

**Mustard**

Cut and butter rolls. Fill to taste with cheese, meat, and mustard. Wrap each roll in foil. Place rolls on the edge of the coals or on grill above the coals for about 1/2 to 1 hour.



### *Great Outdoors Potatoes*

*Reggie Levack, Brantford, Ontario*

**FOIL**

- 6 Potatoes**
- 2 ts Lemon juice**
- 1 ts Dijon mustard**
- 1 Pureed garlic clove**
- 1/4 c Olive oil**
- 1/2 ts Corriander**
- 1 ts Minced onion**
- 1/2 ts Fresh ground peppper**
- 1 ts Paprika**

Scrub potatoes and cut into quarters, keeping skins on. Boil until tender, and coat them with the dressing which you can prepare in advance. Wrap the potato quarters in tin foil, and place on coal to brown. Delicious with meat or fish.

Origin: Ms. Reggie Levack, Brantford, Ontario. From Canadian Living magazine, Alcan Tin Foil Ad. Shared by: Sharon Stevens

*Complete Meal*                      *Troop 421*                      **FOIL**

- Meat**
- celery**
- Potatoes**
- BBQ sauce**
- carrots**
- seasonings**
- onions**
- corn**

Make a tightly sealed pouch with the foil, double layered. Place the veggies in foil, then the meat. Add sauce if desired. The trick to this meal is to use lots of veggies. They provide the moisture and flavor the meat.

Foil cooking times in minutes

Hamburger	8-12	Chicken pieces	10-30
Wieners	5-10	Pork chops	15-20
Whole potatoes	45-60	Ears of corn	10-15
Potato slices	10-15	Carrots	15-20
Whole apples	20-30		

*Pi-Chee Ham*                                      *Ed Bailey*                                      **FOIL**

- 1 can candied yams**
- a pat of butter**
- 1 can SPAM,**
- dash brown sugar**

Slice SPAM into a double or triple layer foil pack. Put in candied yams, the SPAM, a pat of butter and sprinkle some brown sugar on top. Seal the pack and heat on the coals for eight minutes a side. Tastes like candied ham and yams.

*Sue's Goulash*                                      *Ed Bailey*                                      **FOIL**

- 1/2 cup of Minute Rice**
- dried onion flakes**
- canned chicken, beef, or chopped ham**
- dry seasoning, or gravy ingredients**

Form three (3) sheets of foil into a bowl shape. Put in the bottom, sprinkle and mix dried onion flakes, dry seasoning, or gray ingredients. Add some canned chicken, beef, or chopped ham. Pour in 1/2 cup water. Seal and place on coals for 15 minutes.

*Cheese Potatoes in a Parcel*

*Annette Wolter*

**FOIL**

**1 Med. Potato, peeled and sliced**  
**1 slice Bacon, diced**  
**1 tbs. Butter or Margarine**

**2 oz. Cheese cut in cubes**  
**3 slices onion, separated into rings**  
**salt, pepper, paprika**

Use a double thick piece of heavy duty foil. With a little oil, lay the potatoes on the foil, distributing the slices evenly, and season with a little salt, pepper, and paprika. Scatter the cheese and bacon and onion rings evenly over the potatoes, sprinkle the butter pieces on top. Fold the foil to form a parcel, closing the edges carefully.

Cook the cheese potatoes over a charcoal grill for 50 minutes, turning the parcel repeatedly. You can use dried diced onions and dried bacon, but add a few tbs. water.

*Rice on the Coals*

**FOIL**

**1 1/2 cups minute rice**  
**1/2 tsp. salt**

**1 1/2 cups water**  
**dash pepper**

**1 T. margarine**  
**4 tsp. instant bouillon**

Place two sheets of foil (14" sq.) on top of each other in a cooking pot. Press into a bowl or pouch. Add ingredients and seal tightly. Remove from pot and place on coals for 15 minutes. serves 4

*Sauced Dogs*

*Ed Bailey*

**FOIL**

**1/2 LB hot dogs**  
**1 hard boiled egg**  
**1 Tbs. pickle relish**  
**1/2 tsp. garlic salt**

**1/2 cup cheddar cheese**  
**2 Tbs. chili sauce**  
**1/2 tsp. mustard**

At home, grind together: 1/2 lb. hot dogs, 1/2 cup mild cheddar cheese. Add 1 chopped hard boiled egg, 2 T. chili sauce, 1 T. pickle relish, 1/2 tsp. mustard, 1/2 tsp. garlic salt. At camp spread this mess, I mean mixture, on buns. Wrap in double heavy foil. Heat on coals 10 min. (serves 3-4)

*Foil Baked Fish*

*Ed Bailey*

**FOIL**

**filleted fish**  
**lemon**

**onion**  
**tomato**

**salt & pepper**

Lay out a strip of heavy doubled foil and butter generously. Lay out a filleted fish on the foil. Sprinkle with salt and pepper. Cover with onion rings, lemon slices, tomato slices. Seal tightly with foil and place on a grill over the coals. When steam balloons the foil prick it once. A large filleted fish is ready to eat in 20-30 minutes. **Chef's secret:** If your fish tend to be dry, add a can of tomato sauce.

*Texas Tators*

*Troop 421*

**FOIL**

**4 large potatoes**  
**BBQ sauce**  
**Butter or margarine**

**Chopped Beef (pre-cooked)**  
**Cheese**  
**Heavy duty Foil**

Poke a few holes in the potatoes with a fork. Wrap potatoe in foil and place on hot coals for about 1 hour, turning each 30 minutes. Mix BBQ sauce and pre-cooked beef. Heat Mix. When potatoes are done top with ingredients to taste.

*Sweet, Sweet Potatoes (3-4 ser.)*      *Ed Bailey*      **FOIL**

**1 can sweet potatoes**      **margarine**      **maple flavored syrup**

Remove completely the top from a 18 oz. can of sweet potatoes. Strip off Label. Drain some of the liquid into a cup, and add 1/4 cup maple flavored syrup and 1 T. margarine. Return liquid to cover the sweet potatoes. Cover can with foil. Place on a grill or near coals and heat until bubbly, about 20 min.

*Baden Baked Sliced Potatoes*      *Ed Bailey*      **FOIL**

**potato**      **margarine**      **foil**      **salt, pepper, garlic salt**

Scrub and cut potatoes into thick slices. Use one potato per person. Do not peel the potatoes. Place each one on a double sheet of heavy foil. Add 1 T. margarine. Sprinkle with garlic, onion salt and pepper. Seal and bake on the grill, turning often for a hour. or 15-20 minutes on coals.

*Drumsticks*      *Stick & Foil*

**1 lb hamburger**      **1 cup cornflakes**      **1 egg**      **1/2 chopped onion**  
**salt & pepper**      **1 tsp. mustard**      **1 tbl. ketchup**

Crush the cornflakes and mix with all the rest of the ingredients, except egg shell. Warp a handfull around a green stick and wrap aluminum foil around meat and stick. cook 20 - 30 min. over bed of coals, turning slowly. Makes about 6-7 drumsticks.

*Foiled Onions*      *Ed Bailey*      **FOIL**

**Large onion**      **margarine**      **salt & pepper**      **bacon**      **foil**

Peel a large onion and cut in half. Place a pat of margarine on the cut side and sprinkle with salt and pepper. Top with a half strip of bacon on each half onion. Wrap each in double heavy foil and seal tightly. Bake on coals 35-45 minutes. (1 onion for 2 persons)

*Hot Chicken Sandwiches*      *Ed Bailey*      **FOIL**

**1 can boned chicken**      **1 cup chopped celery**

**1/4 cup sliced ripe olives      1/4 cup shredded jack cheese,  
1/4 cup mayonnaise            1 tsp. dry onion flakes            hamburger buns**

Combine 1 can boned chicken, 1 cup chopped celery, 1/4 cup sliced ripe olives, 1/4 cup shredded jack cheese, 1/4 cup mayonnaise, 1 tsp. dry onion flakes, and spread on hamburger buns. Wrap in double heavy foil and heat over coals 15-20 min.(serves 3-4)

**Add your own Foil Recipe here**

## SPAM Hall of Cans (Fame)

A special place for that all purpose potted meat.

*SPAM<sup>®</sup> Quesadillas*

*Hormel*

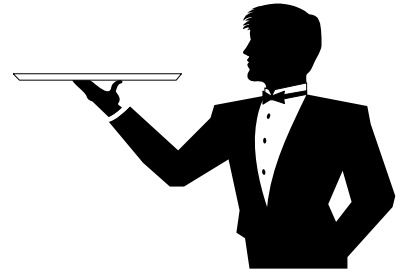

- 1 (12-ounce) can SPAM Luncheon Meat, chopped**
- 4 cups shredded Monterey Jack cheese with peppers**
- 6 (8-inch) flour tortillas**
- Guacamole and Salsa**

Combine SPAM and cheese. Spoon meat mixture over 3 tortillas. Top with remaining tortillas. In lightly greased griddle, heat filled tortilla over medium high heat until soft and cheese is melted, turning once. Repeat with remaining tortillas. Cut each tortilla stack into 6 wedges. Serve with guacamole or salsa. Makes 18 appetizer servings.

NUTRITIONAL INFORMATION PER SERVING: Calories 166; Protein 10 g; Carbohydrate 7 g; Fat 11 g; Cholesterol 37 mg; Sodium 366 mg.

*Hawaiian Rice*

- 1 can (7oz.) Spam**
- 1-1/3 cups instant rice**
- 1/3-1/2 cup flaked coconut**
- margarine**

Melt 1 Tbls margarine in a frying pan. Add cubed Spam and rice and brown slightly. Add 1-1/3 cups water and bring to a boil. Cover and remove from heat for 5 minutes. Add coconut and toss to mix. 2 servings.

*SPAM<sup>®</sup> Nachos*

*Hormel*

- 1 (12-ounce) can SPAM Luncheon Meat, cubed**
- 1 (10 1/2-ounce) bag Tortilla Chips**
- 1 (15-ounce) can Refried Beans**
- 1 (16-ounce) jar Salsa**
- 1 (8-ounce) package shredded Mexican pasteurized processed cheese**

Heat oven to 425°F. Place chips on baking sheet. Sprinkle SPAM over chips. In bowl, combine refried beans and salsa; pour over chips. Sprinkle with cheese. Bake 6 to 7 minutes or until cheese is melted. Serve immediately. Makes 10 appetizer servings

NUTRITIONAL INFORMATION PER SERVING: Calories 361; Protein 16g; Carbohydrate 28 g; Fat 21g; Cholesterol 48 mg; Sodium 1034 mg.

*Pi-Chee Ham*

*Ed Bailey*

**FOIL**

**1 can candied yams  
a pat of butter**

**1 can SPAM,  
dash brown sugar**

Slice SPAM into a double or triple layer foil pack. Put in candied yams, the SPAM, a pat of butter and sprinkle some brown sugar on top. Seal the pack and heat on the coals for eight minutes a side. Tastes like candied ham and yams.

*SPAMBURGER Hamburgers*

*Hormel*

<b>1</b>	<b>(12-ounce) can SPAM Luncheon Meat</b>	<b>6</b>	<b>hamburger buns, split</b>
<b>3</b>	<b>tablespoons mayonnaise or salad dressing</b>	<b>6</b>	<b>lettuce leaves</b>
<b>2</b>	<b>tomatoes, sliced</b>	<b>6 (1-ounce)</b>	<b>slices American cheese</b>

Slice SPAM into 6 slices (3 inches x 1/4-inch). In skillet, sauté SPAM over medium heat until lightly browned. Spread cut sides of buns with mayonnaise. Layer lettuce, tomato, SPAM, and cheese on bun bottom. Cover with bun top. Serves 6.

NUTRITIONAL INFORMATION PER SERVING: Calories 405; Protein 20g; Carbohydrate 25 g; Fat 25g; Cholesterol 76 mg; Sodium 1280 mg.

*SPAM-a-Rama MAC*

*T753*

**1 (12-ounce) can SPAM® Luncheon Meat**  
**1 (12-ounce) Bag Macaroni noodles**  
**1 can green peas**  
**1 cup shredded Cheddar cheese, divided**  
**1 cup shredded Monterey Jack cheese, divided**  
**1 onion or dried onions**

Cook the noodles in a large pot. While noodles cook. Cube the SPAM and brown with the onion in a skillet. Drain the noodles and add 2 tbl. margarine and a cup of milk. add the cheese and melt. then add the SPAM and onions.

*California SPAMBURGER® Hamburger*

*Hormel*

- |   |  |
|---|--|
| <b>1 (12-ounce) can SPAM® Luncheon Meat</b>         | <b>6 whole wheat hamburger buns, split</b> |
| <b>3 tablespoons Thousand Island salad dressing</b> | <b>6 lettuce leaves</b>                    |
| <b>2 tomatoes, sliced</b>                           | <b>6 green bell pepper rings</b>           |
| <b>6 onion slices</b>                               |  |

Slice SPAM' into 6 slices (3 inches x 1/4 inch). In skillet, sauté SPAM over medium heat until lightly browned. Spread cut sides of bun with dressing. Layer lettuce, SPAM, tomato, green pepper, and onion on bun bottom. Cover with bun top. Serves 6.

NUTRITIONAL INFORMATION PER SERVING: Calories 287; Protein 14 g; Carbohydrate 28 g; Fat 13g; Cholesterol 47 mg; Sodium 891 mg.

*Savory SPAM Crescents*

*Hormel*

- |  |  |
|--|--|
| <b>1 (12-ounce) can SPAM Luncheon Meat, cubed</b>            |  |
| <b>10 slices bacon, cut in small pieces</b>                  | <b>1/4 cup finely chopped onion</b>      |
| <b>3 tablespoons grated Parmesan cheese</b>                  | <b>1 egg, beaten</b>                     |
| <b>2 tablespoons chopped fresh parsley</b>                   | <b>2 tablespoons Dijon-style mustard</b> |
| <b>2 (8-ounce) packages refrigerated crescent roll dough</b> | <b>1/8 teaspoon pepper</b>               |

Heat oven to 375°F In skillet, cook bacon and onion until bacon is crisp; drain. Stir in remaining ingredients except crescent roll dough. Separate each package of crescent dough into 8 triangles. Spread top half of each triangle with SPAM mixture; roll up. Place on baking sheets. Bake 12 to 15 minutes or until golden brown. Serves 16.

NUTRITIONAL INFORMATION PER SERVING: Calories 127; Protein 7 g; Carbohydrate 6 g; Fat 9g; Cholesterol 34 mg; Sodium 439 mg.

*Maui SPAM Muffins*

*Hormel*

- |  |                            |                         |
|--|----------------------------|-------------------------|
| <b>4 English muffins, split and toasted</b>              | <b>Butter or margarine</b> | <b>Prepared mustard</b> |
| <b>1 (7-ounce) can SPAM Luncheon Meat, thinly sliced</b> |                            |                         |
| <b>1 (15 1/4-ounce) can pineapple slices, drained</b>    |                            |                         |
| <b>1 small green pepper, cut into 8 rings</b>            |                            |                         |
| <b>1/4 cup firmly packed brown sugar</b>                 | <b>2 teaspoons water</b>   |                         |

Heat oven to 375°F. Spread muffins with butter and mustard. Overlap SPAM slices on each muffin half. Place a pineapple slice and a green pepper ring on each muffin. Combine brown sugar and water; spoon over sandwiches. Place muffins on baking sheet. Bake 10 minutes. Serve hot. Serves 8.

NUTRITIONAL INFORMATION PER SERVING: Calories 179; Protein 7 g; Carbohydrate 29 g; Fat 4g; Cholesterol 20 mg; Sodium 437 mg.

*SPAM Breakfast Bagels*      *Hormel*

**1 (12-ounce) can SPAM Luncheon Meat**      **2 tablespoons butter or margarine**  
**6 eggs, beaten**      **6 (1-ounce) slices American cheese**  
**6 bagels, sliced**

Slice SPAM into 6 slices (3 inches x 1/4 inch). In skillet, sauté SPAM over medium heat until lightly browned. Remove from skillet; keep warm. In same skillet, melt butter; pour in beaten eggs. Cook and stir to desired doneness. Layer scrambled eggs, SPAM and cheese on bagel bottom. Cover with bagel top. Serves 6.

NUTRITIONAL INFORMATION PER SERVING: Calories 504; Protein 29g; Carbohydrate 36 g; Fat 27 g; Cholesterol 294 mg; Sodium 1367 mg.

*SPAM Fajitas*      *Hormel***Vegetable cooking spray**

**1 green bell pepper, cut into julienne strips**  
**1 (12-ounce) can SPAM' Luncheon Meat, cut into julienne strips**  
**3/4 cup Salsa**  
**1/2 onion, cut into 1/4-inch slices**  
**8 (8-inch) flour tortillas, warmed**  
**2 cups shredded lettuce**  
**1/2 cup shredded hot pepper Monterey Jack or Cheddar cheese**  
**1/2 cup nonfat plain yogurt**  
**Extra salsa, if desired**

Spray large non-stick skillet with vegetable cooking spray. Heat skillet over medium high heat. Sauté green pepper and onion 2 minutes. Add SPAM, Sauté 2 minutes. Stir in salsa and heat thoroughly. Spoon about 1/2 cup SPAM mixture into each flour tortilla. Top each with 1/2 cup shredded lettuce, 1 tablespoon shredded cheese, 1 tablespoon yogurt, and extra salsa, if desired. Serves 8.

NUTRITIONAL INFORMATION PER SERVING: Calories 237; Protein 12 g; Carbohydrate 23 g; Fat 11 g; Cholesterol 40 mg; Sodium 625 mg.

*The Original Baked SPAM*

*Hormel*

- 1 (12-ounce) can SPAM Luncheon Meat**
- Whole cloves 1/3 cup firmly packed brown sugar**
- 1 teaspoon water 1 teaspoon prepared mustard**
- 1/2 teaspoon vinegar**

Heat oven to 375°F Place SPAM on rack in shallow baking pan. Score surface; stud with cloves. Combine brown sugar, water, mustard, and vinegar, stirring until smooth. Brush glaze over SPAM. Bake 20 minutes, basting often. Slice to serve. Serves 6.

NUTRITIONAL INFORMATION PER SERVING: Calories 156; Protein 9 g; Carbohydrate 12 g; Fat 8 g; Cholesterol 45 mg; Sodium 575 mg.

*SPAM Hashbrown Bake*

*Hormel*

- 1 (32-ounce) package frozen hash-brown potatoes, thawed slightly**
- 1/2 cup butter or margarine, melted**
- 2 cups shredded Cheddar cheese**
- 1 (12-ounce) can SPAM Luncheon Meat, cubed**
- 1 (10 1/4-ounce) can cream of chicken soup**
- 1/2 teaspoon garlic powder 1 1/2 cups sour cream**
- 1 teaspoon salt 1 teaspoon pepper**
- 1/2 cup milk 1/2 cup chopped onion**
- 1/4 cup Diced Green Chilies, drained**
- 2 cups crushed potato chips**

Heat oven to 350°F. In large bowl, combine potatoes, melted butter, salt, pepper, and garlic powder. In another bowl, combine cheese, SPAM, soup, sour cream, milk, onion, and green chilies. Add SPAM mixture to potato mixture; mix well. Pour into 2-quart baking dish. Sprinkle with potato chips. Bake 45 to 60 minutes or until thoroughly heated. Serves 8.

NUTRITIONAL INFORMATION PER SERVING: Calories 705; Protein 21g, Carbohydrate 41 g; Fat 53 g; Cholesterol 118 mg; Sodium 1447 mg.

*SPAM Breakfast Burritos*

*Hormel*

- 1 (12-ounce) can SPAM Luncheon Meat, cubed**
- 1 tablespoon butter or margarine 2 tablespoons milk**
- 6 (6-inch) flour tortillas 4 eggs**
- 1 cup shredded Cheddar cheese, divided**
- 1 cup shredded Monterey Jack cheese, divided**
- Salsa or Taco Sauce**

Heat oven to 400°F In bowl, beat together SPAM eggs, and milk. Melt butter in large skillet; add egg mixture. Cook, stirring, to desired doneness. Fill each tortilla with SPAM mixture and half of cheeses. Roll burrito; place seam side down on 12 x 8-inch baking dish. Sprinkle remaining cheese over top of burritos. Bake 5 to 10 minutes or until cheese is melted. Serve with salsa. Serves 6.

NUTRITIONAL INFORMATION PER SERVING: Calories 430; Protein 25g; Carbohydrate 20 g; Fat 28 g; Cholesterol 562 mg; Sodium 976 mg.

*SPAM Skillet Dinner*

*Hormel*

- |            |                                |            |  |
|------------|--------------------------------|------------|--|
| <b>3</b>   | <b>medium zucchini</b>         | <b>1</b>   | <b>onion, thinly sliced</b>              |
| <b>1</b>   | <b>tablespoon oil</b>          | <b>1</b>   | <b>(12-ounce) can SPAM Luncheon Meat</b> |
| <b>1</b>   | <b>(16-ounce) can tomatoes</b> | <b>3</b>   | <b>medium potatoes, peeled, sliced</b>   |
| <b>1/2</b> | <b>teaspoon garlic powder</b>  | <b>1/4</b> | <b>teaspoon basil</b>                    |
| <b>1/2</b> | <b>teaspoon oregano</b>        |            |  |

Cut zucchini in 1/2-inch slices. In large skillet over medium-high heat, sauté zucchini and onion in oil 5 minutes, stirring often. Cut SPAM into 8 slices; halve each slice. Add potatoes, carrots, and SPAM to skillet; pour tomatoes over all. Sprinkle with herbs. Cover and simmer 25 minutes or until potatoes are tender, stirring occasionally. Serves 8.

NUTRITIONAL INFORMATION PER SERVING: Calories 176; Protein 9g; Carbohydrate 18g, Fat 8g; Cholesterol 34 mg; Sodium 526 mg.

*SPAM Fried Rice*

*Hormel*

- |            |                                 |            |   |
|------------|---------------------------------|------------|---|
| <b>2</b>   | <b>eggs, beaten</b>             | <b>1</b>   | <b>(12-ounce) can SPAM Luncheon Meat, cubed</b> |
| <b>1/4</b> | <b>cup chopped green onion</b>  | <b>1/4</b> | <b>cup finely chopped mushrooms</b>             |
| <b>2</b>   | <b>tablespoons oil, divided</b> | <b>2</b>   | <b>cups cooked rice</b>                         |
| <b>3</b>   | <b>tablespoons soy sauce</b>    |            |   |

In large skillet, heat 1 tablespoon oil. Add eggs. Cook, stirring, to desired doneness. Remove from skillet. In same skillet, heat remaining 1 tablespoon oil. Cook SPAM, mushrooms, and green onion 4 minutes or until vegetables are tender. Stir in rice and egg. Sprinkle with soy sauce. Heat thoroughly. Serves 4 to 6.

NUTRITIONAL INFORMATION PER SERVING: Calories 405; Protein 20g, Carbohydrate 31g; Fat 22g; Cholesterol 174 mg; Sodium 1646 mg.

*SPAM HASH*

- 1 can SPAM**                      **1/4 lb Bacon**                      **1/2 Minced Onions**
- Parsley**                              **1 can Boiled Diced Potatoes**

Preparation:

Cut SPAM and bacon into bite size pieces. Saute bacon until brown. Add minced round onion until tender. Then add SPAM and boiled cubed potatoes, brown until SPAM and potatoes are golden. Add parsley and serve.

*Hearty SPAM Breakfast Skillet*                      *Hormel*

- 2 cups frozen diced or shredded potatoes**
- 1/2 cup chopped onion**
- 1/4 medium green bell pepper, cut into 1-inch thin strips**
- 1/4 medium red or yellow bell pepper, cut into 1-inch thin strips**
- 2 teaspoons oil**
- 1 (12-ounce) can SPAM Luncheon Meat, cut into julienne strips**
- 1 (8-ounce) carton frozen fat-free egg product, thawed, or 4 eggs**
- 1/4 teaspoon dried basil**                              **1/2 teaspoon salt**
- 1/8 teaspoon pepper**                                      **6 drops hot pepper sauce**
- 1/4 cup shredded Cheddar cheese**

In large non-stick skillet, cook potatoes, onion, and peppers in oil over medium high heat 5 minutes, stirring constantly. Add SPAM; cook and stir 5 minutes. In small bowl, combine egg product, basil, salt, pepper, and hot pepper sauce; blend well. Pour over mixture in skillet. Cover. Cook over medium-low heat 8 to 12 minutes or until set. Sprinkle with cheese; remove from heat. Serves 6.

NUTRITIONAL INFORMATION PER SERVING: Calories 294; Protein 17 g; Carbohydrate 17 g; Fat 18 g; Cholesterol 50 mg; Sodium 725 mg.

*SPAM Meal in a Bundle*                                      *Hormel*                                      *FOIL*

- 1/4 cup firmly packed brown sugar**                              **1/4 cup stone ground mustard**
- 1/4 cup beer (non-alcohol )**                                      **1/2 teaspoon celery seed**
- 8 new potatoes, sliced 1/4-inch thick**                              **2 cups carrots, sliced 1/4-inch thick**
- 1 onion, thinly sliced**
- 1 (12-ounce) can SPAM Lite Luncheon Meat, sliced**

Heat oven to 375°F. In bowl, combine brown sugar, mustard, beer, and celery seed. Divide vegetables and SPAM' on four 12-inch square pieces of foil. Drizzle mustard mixture over vegetables. Fold foil to form packets. Bake 45 to 60 minutes or until hot. Serves 4.

NUTRITIONAL INFORMATION PER SERVING: Calories 411; Protein 20 g; Carbohydrate 55 g; Fat 13 g; Cholesterol 68 mg; Sodium 1073 mg.

*Spicy SPAM Kabobs*

*Hormel*

- |            |  |            |                                      |
|------------|--|------------|--------------------------------------|
| <b>1/4</b> | <b>cup lemon juice</b>   | <b>3</b>   | <b>tablespoons minced onion</b>      |
| <b>1</b>   | <b>tablespoon olive oil</b>  | <b>1</b>   | <b>teaspoon dried leaf thyme</b>     |
| <b>1</b>   | <b>clove garlic, minced</b>  | <b>1/2</b> | <b>teaspoon whole oregano leaves</b> |
| <b>1/4</b> | <b>teaspoon red pepper flakes</b>                                    |            |                                      |
| <b>1</b>   | <b>(8-ounce) can pineapple chunks packed in light juice, drained</b> |            |                                      |
| <b>1</b>   | <b>(1 2-ounce) can SPAM Lite Luncheon Meat, cut into 24 cubes</b>    |            |                                      |
| <b>1</b>   | <b>red bell pepper, cut into 1-inch pieces</b>                       |            |                                      |
| <b>4</b>   | <b>cups hot cooked rice</b>  | <b>16</b>  | <b>pea pods</b>                      |

Combine first 7 ingredients in 9 x 12-inch dish. Wrap pea pods around pineapple chunks. Alternately thread SPAM cubes, pineapple chunks, and bell pepper pieces on eight skewers. Place in dish with marinade. Cover and marinate 2 hours, turning occasionally. Grill kabobs over medium-hot coals 10 minutes, turning occasionally. Or, broil 5 inches from heat source 8 to 10 minutes, turning occasionally. Serve with hot cooked rice. Serves 4.

NUTRITIONAL INFORMATION PER SERVING: Calories 536; Protein 22 g; Carbohydrate 75 g; Fat 16 g; Cholesterol 68 mg; Sodium 848 mg.

*SPAM Jambalaya*

*Hormel*

- |            |  |               |                                      |
|------------|--|---------------|--------------------------------------|
| <b>1</b>   | <b>(12-ounce) can SPAM Lite Luncheon Meat, cubed</b> |               |                                      |
| <b>1</b>   | <b>(10 3/4-ounce) can lower sodium chicken broth</b> |               |                                      |
| <b>1</b>   | <b>cup chopped onion</b>                             | <b>2/3</b>    | <b>cup chopped green bell pepper</b> |
| <b>1/2</b> | <b>cup chopped celery</b>                            | <b>2</b>      | <b>cloves garlic, minced</b>         |
| <b>1</b>   | <b>(14 1/2-ounce) can tomatoes, cut up</b>           | <b>2</b>      | <b>tablespoons chopped parsley</b>   |
| <b>1/2</b> | <b>teaspoon dried leaf thyme</b>                     | <b>6 to 8</b> | <b>drops hot pepper sauce</b>        |
| <b>1</b>   | <b>bay leaf</b>                                      | <b>1</b>      | <b>cup long grain rice</b>           |

In large non-stick skillet or 3-quart non-stick saucepan, sauté SPAM onion, green pepper, celery, and garlic until vegetables are tender. Add tomatoes, chicken broth, thyme, hot pepper sauce, and bay leaf. Bring to a boil; stir in rice. Cover. Reduce heat and simmer 20 minutes or until rice is tender. Discard bay leaf. Sprinkle with parsley. Serves 6.

NUTRITIONAL INFORMATION PER SERVING: Calories 261; Protein 13 g; Carbohydrate 32 g; Fat 8 g; Cholesterol 45 mg; Sodium 850 mg.

*SPAM Stuffed Potatoes Florentine*

*Hormel*

**Vegetable cooking spray**

- 1**     **teaspoon butter or margarine**
- 1**     **(12-ounce) can SPAM Lite Luncheon Meat, cubed**
- 1/2**   **(10-ounce) package frozen chopped spinach, thawed and squeezed dry**
- 6**     **baking potatoes, baked and kept warm**
- 1/3**   **cup chopped onion**                                 **1/4**   **teaspoon dried leaf thyme**
- 1/4**   **Cup skim milk**   **1/4**   **teaspoon pepper**
- 2**     **tablespoons grated Parmesan cheese**
- 1/4**   **cup shredded Monterey Jack cheese**
- 1/4**   **cup shredded Cheddar cheese**

Heat oven to 350°F. Spray a shallow rectangular 2-quart baking dish with vegetable cooking spray. In a large nonstick skillet, sauté SPAM in butter 3 minutes. Add onion, spinach, and thyme; cook and stir 2 minutes. Set aside. Cut a thin slice off the top of each potato. Scoop out each potato, leaving a 1/2-inch shell. Place shells in prepared baking dish. Place scooped out potato in medium mixing bowl. Beat at medium speed 30 seconds. Add milk, Parmesan cheese, and pepper; beat just until combined. Stir in SPAM mixture. Fill potato shells with potato mixture. Bake, uncovered, 25 to 30 minutes or until thoroughly heated. Top with cheeses. Bake 5 minutes longer or until cheese is melted. Serves 6.

NUTRITIONAL INFORMATION PER SERVING: Calories 396; Protein 18 g; Carbohydrate 54g; Fat 12 g; Cholesterol 56 mg; Sodium 704 mg.

*SPAM Fajitas*

*Patrick Welch*

*T928*

*Skillet*

- 1 can SPAM, sliced into 3/8" strips,**
- 1 green pepper sliced**                                 **Salsa,**
- 
- 1 small onion, sliced,**
- 10 flour tortillas**

Fry the SPAM, onions and peppers. Add the Salsa. Heat the tortillas and spoon on the Mixture. Roll and eat.

*SPAM on a Stick*

*Unknown Desperate Soul*

- 1 can (7 oz) SPAM**

Cut SPAM into 6 long spears, place on sticks or long fork and cook over open fire. Top with brown mustard or Grey Poupon.

*Healthy SPAM Peppers*

*Hormel*

- |          |  |              |   |
|----------|--|--------------|---|
| <b>1</b> | <b>(12-ounce) can SPAM Lite Luncheon Meat, cubed</b> |              |   |
| <b>2</b> | <b>cups shredded cabbage</b>                         | <b>1</b>     | <b>cup shredded zucchini</b>                  |
| <b>1</b> | <b>onion, shredded</b>                               | <b>1</b>     | <b>carrot, shredded</b>                       |
| <b>2</b> | <b>cloves garlic, minced</b>                         | <b>1 1/2</b> | <b>tablespoons chopped fresh basil leaves</b> |
| <b>1</b> | <b>teaspoon dried oregano</b>                        | <b>1/2</b>   | <b>teaspoon red pepper flakes</b>             |
| <b>1</b> | <b>(28-ounce) can diced tomatoes</b>                 | <b>1 1/2</b> | <b>cups instant rice</b>                      |
| <b>1</b> | <b>tablespoon brown sugar</b>                        | <b>8</b>     | <b>bell peppers, cored and seeded</b>         |

In skillet over medium-high heat, sauté SPAM until lightly browned; remove from skillet. Add cabbage, zucchini, onion, carrot, garlic, basil, oregano, and red pepper flakes to skillet. Cook over low heat 10 minutes or until vegetables are crisp-tender. Drain juice from tomatoes; reserve juice. Add enough water to tomato juice to make 2 cups. Add juice, tomatoes, SPAM, rice, and brown sugar to vegetable mixture. Cover. Cook 10 minutes. In large saucepan, boil bell peppers in water 5 to 7 minutes or until crisp-tender. Drain. Fill peppers with SPAM mixture. Serves 10.

NUTRITIONAL INFORMATION PER SERVING: Calories 215; Protein 11g; Carbohydrate 30 g; Fat 7 g; Cholesterol 34 mg; Sodium 444 mg.

*Ham 'N Green Bean Bake*

*Ed Bailey*

**FOIL**

- |   |                                 |                                 |
|---|---------------------------------|---------------------------------|
| <b>Combine 1 1/3 cups minute rice</b>   | <b>1 cup diced ham or SPAM,</b> |                                 |
| <b>1 can (8 oz) drained green beans</b> | <b>1/3 cup mayonnaise</b>       | <b>2 tsp. dry onion flakes.</b> |

Stir in **1 1/3 cups hot chicken bouillon or chicken soup**. Sprinkle with grated **Parmesan cheese**. Shape a triple thickness of heavy foil into a bowl. Add mixture and seal. Leave over hot coals for 30 minutes.(serves 3-4)

*SPAM, I am*

*Sam*

- |                                     |                                     |
|-------------------------------------|-------------------------------------|
| <b>7 oz can SPAM</b>                | <b>6 oz Egg and Spinach Noodles</b> |
| <b>1 can Cream of Mushroom Soup</b> | <b>1 small onion</b>                |

Dice the SPAM into 1/2 inch chunks. Fry with sliced onion in a light oil. Cook the noodles until done. Drain water, reserve 1 can to mix with soup. Add soup and SPAM mixture. Heat through and serve 4.

*The SPAM and I*

*Dennis A. Schmitt*

**ONEPOT**

- |                                      |                          |
|--------------------------------------|--------------------------|
| <b>1 can SPAM, sliced and diced</b>  | <b>1 cup Minute rice</b> |
| <b>1 can cream of Mushroom Soup.</b> |                          |

Heat the SPAM in a deep skillet, add the soup and heat. Boil 3/4 cup water and cook the rice as directed. Pour the SPAM and soup over beds of rice. Variations... wild rice, Cream of Corn Soup...

*MAPS Chili*

*Fred Mertze*

**1 can diced SPAM**                    **1/2 onion or 2 T. dried onion flakes**  
**4 oz. green chili**                    **1 Tomato    garlic salt and pepper**  
**1/2 cup cheese**                      **1/3 cup water**

Brown the SPAM and the onion, chili. Add water and tomato wedges. Simmer 20 minutes. Place cheese on top and melt. Serves 2-3.

*Pepsi SPAM*

*Dennis A. Schmitt*

**1 can SPAM**                    **1 can Regular Pepsi not Diet**                    **tortillas, bread or buns**  
**cheese**                      **mustard**

Slice the SPAM, place in a 1 quart pan and pour in a can of Pepsi, do not use diet. Boil for about 5 minutes. This gives the SPAM a sweet caramel taste. Wrap the SPAM slices in tortillas with cheese and mustard, or use bread or buns. Sliced ham can also be used.

**OK I'm full of chopped pork parts now**

## Camp Breads



### *Bannock*

### *Ancient Trailperson's Standby*

**1 cup flour**  
**dash salt**

**1/3 tablespoon (1 teaspoon) baking powder**  
**oil or margarine**                      **water**

*At home:*        package the flour, baking powder, and salt together in a large, tough plastic bag.  
*In the field:*    Put a little oil of margarine into the bag, and slowly add enough water to give the mixture the consistency of dough. You may have to mix it with your hands. Flatten it out into a cake, and fry it in a little oil, very slowly. Note: If you end up with a bread that has its outside a delicious, golden brown and its inside a uncooked, doughy mass, do not despair. Just pretend you're an ancient trailperson.

### *Bisquick Bannock*

### *Modern Trailperson's Standby*

**6-8 tablespoons water**  
**3 Tablespoons oil or margarine**

**1 cup Bisquick buttermilk baking mix**

*At home:*        Package the baking mix in a large, tough plastic bag. *In the field:* Put a 3-4 Tbls oil or margarine into the bag, and slowly add enough water to give the mixture the consistency of dough. You may have to mix it with your hands. Flatten it out into a cake, about 1/2 inch thick and fry it in a little oil, very slowly over coals or lowest possible flame. Fry it, as gently as possible, turning it often. After the bottom is browned, prop the pan up in front of the fire's flames to brown the top.

1. The batter should not be too thick - 1/2 inch is enough
2. Use straight sided fry pan, curved sides allow slips when propped before the fire.
3. Aluminum skillets get too hot too quick.
4. Don't prop up the pan until the bottom is browned.

Also try putting the dough in a zip-lock freezer bag. Place on rack in covered pot of boiling water. Let the steam 'bake' the bread. Add raisins and cinnamon, or serve with honey when done.

### *Rayado Biscuits*

### *Dutch Oven*

**Biscuit Mix**

**Flour**

Mix 12 - 18 oz biscuit mix as directed and pat out on a floured, flat surface. Cut biscuits with a small open end can and place 20-24 biscuits in oven. Cover and bake about 15 minutes. Can also use floured hands and balls of dough 1 1/2 ", flatten and placed in oven. Or spoon the mixed dough and drop into oven without shaping.

### *Mount Logan Bread*

<b>3 cups flour (white or whole wheat)</b>	<b>1/2 cup chopped dried fruit</b>
<b>1/2-1 cup shelled nuts (walnuts, pecans, cashews, peanuts)</b>	<b>1 cup honey</b>
<b>3/4 cup wheat germ</b>	<b>1/4 cup brown sugar</b>
<b>1/2 cup powdered milk</b>	<b>1/2 cup raisins</b>
	<b>6 eggs</b>
	<b>2 Tbls. Peanut oil</b>

Mix dried ingredients, then stir in oil, honey and eggs. Spray a 9 x 5-1/3 x 2-2/3 inch bread pan with a non-stick coating. Pour in batter and tap the pan on the counter. Bake in a preheated 275 degree oven for 2 hours. Cool 10 minutes before taking out of pan. Yield: 18 slices.

*Dan Beard Camp Bread*

**2 cups biscuit mix    1/2 cup plus 1 tablespoon milk**

1. Stir the ingredients together; this will make a very thick dough. Add a few teaspoons of milk if necessary. Shape it like a bread loaf, and dust with additional biscuit mix or flour.
2. Grease a large sheet of foil heavily. Place the dough on the foil and wrap it loosely so the foil package will not burst when the dough rises. Wrap the dough loosely again to cover the seams and crimping
3. Place the bread package at the edge of the coals and turn every 10 minutes for about 1 1/2 hours, depending on the intensity of the heat.      Yield: 1 loaf

*Indian Fry Bread*

**3 cups flour                      3 tsp. Baking powder                      1 tsp. salt**

At camp add 1-1/2 1-2/3 cups water... just enough to form a biscuit dough consistency. Knead well until the dough is elastic and doesn't stick. (Have some extra flour available)  
 For 7-8 inch rounds, use a piece of dough the size of a lemon. Pat by hand into a flat round shape. Fry in deep fat, turning once. The bread should be crisp on the outside. Serve hot.

*Cimaron Cinnamon Rolls*

*Dutch Oven*

<b>2 6-oz pkg. biscuit mix flour</b>	<b>1 cup brown sugar</b>
<b>3 4-oz raisins</b>	<b>cinnamon</b>

Mix the biscuit mix as directed and pat out in a rectangular shape on a floured, flat surface. Spread raisins and brown sugar over the dough and sprinkle with cinnamon. With floured hands roll the dough into a cylinder and cut slices from the rolled cylinder. Place in bottom of Dutch oven. Cover with lid and bake about 15-20 minutes.    serves 8.

*Quick Rolls*

*Linda Patrick*

**2¼ cups biscuit mix, divided**  
**1 (8-ounce) carton sour cream**  
**½ cup butter, melted**

In a large bowl, combine 2 cups biscuit mix, sour cream and butter. Stir well. Sprinkle remaining ¼ cup biscuit mix on a flat surface, breaking up any large lumps with a fork. Drop batter by level tablespoonfuls onto biscuit mix and roll into 36 balls. Place 3 balls into each of 12 greased muffin cups.

Bake in preheated 350-degree oven 20 to 25 minutes, or until rolls are golden brown. Makes 1 dozen.

*Strawberry Bread* from Linda Tubbs' book EZ Breads Cookbook for RVers

<b>2 cups unbleached flour</b>	<b>½ cup sugar</b>
<b>3 tsp. baking powder</b>	<b>½ tsp. salt</b>
<b>½ tsp. baking soda</b>	<b>½ cup chopped walnuts</b>
<b>1-1/2 cups fresh strawberries, mashed (with juice)</b>	
<b>2 tbs. fat-free butter/marg.</b>	<b>¼ cup egg substitute (=to 1 egg)</b>

Directions: Preheat oven to 350. Butter two 8- or 9-inch loaf pans. In a large bowl, sift together dry ingredients; add nuts. Combine strawberries & butter in a separate bowl, add eggs & mix well. Add wet mixture to dry, stir just until blended. Pour into loaf pans; bake 55-60 min., or until bread tests done. (Note: Flavor will be better if covered & allowed to sit for a day. Great with cream cheese!)

*Skillet Biscuits*

From A Taste of Texas Ranching: Cooks & Cowboys. These are cooked on top of the stove and resemble campfire bread.

<b>2 cups all-purpose flour</b>	<b>2 tablespoons sugar</b>	<b>1 teaspoon salt</b>
<b>7/8 cup milk</b>	<b>2 teaspoons baking powder</b>	<b>2 tablespoons oil</b>
<b>plus 1 tablespoon oil or butter</b>		

Mix flour, sugar, salt, milk, baking powder and 2 tablespoons oil; turn out on floured board and knead a few times. Shape into biscuits or make one large loaf. Heat remaining tablespoon oil in large skillet. Place dough in skillet and cook over low heat until brown on bottom, about 10 minutes. Turn over and cook other side about 10 more minutes.

Note: You might want to cover the skillet for the first 10 minutes to speed up the process and cook bread more evenly.

**DRINKS**



*Hot Chocolate Drink Mix*

**1 lb. instant powdered milk**      **1/2 lb. powdered sugar or regular**  
**1/2 lb. powdered coffee creamer**      **1 @ 1 lb. can of Nestle's Quick**

Mix in large bowl with wooden or plastic spoon. Store in air-tight, dark container. Pack in plastic bags for camping. 3 Tablespoons in 8-12 oz hot water.

*Hot Cocoa Mix*

**1/3 cup cocoa**      **1 1/3 cup instant nonfat dry milk**  
**1/2 cup sugar**      **2 T. non-dairy creamer powdered**      **dash salt**

Mix, store in airtight container, for 1 cup cocoa, add 1/4 to 1/3 dry mix to 1 cup boiling water.

*Rich and Creamy Cocoa*

*PET Inc.*

**2 cups hot water**      **1/4 cup unsweetened cocoa powder**  
**1/8 tsp. ground nutmeg**      **2 cups Pet® Evaporated Milk**  
**1/4 cup sugar**      **6 large marshmallows**  
**1/4 tps. salt**      **1/4 tsp. ground cinnamon**  
**3/4 tsp. vanilla**

In heavy saucepan, mix hot water, cocoa, sugar, salt, cinnamon, and nutmeg. Cook over medium heat until mix comes to a boil. Stir frequently. Boil 5 minutes, stirring frequently. Reduce heat and add evaporated milk and marshmallows. Heat slowly until marshmallows dissolved. Add vanilla. Remove from heat and beat 1 minute with beater. Serve.

*Hot TANG*

Mix TANG in a cup of hot water for a different breakfast drink

*Pine Tea*

*Euell Gibbons*

Take **fresh broken** pine needles (brown ones don't work) and steep for a few minutes in a cup of boiling water. Remove the needles. Cool down to warm. Rich in vitamin C, but it is an acquired taste.

*Swamp Water*

**2 packages Grape Kool Aid**

**2 Packages Lemon-Lime Kool Aid**

Mix and add water, pre-sweetened or add the sugar.

*Cockerall River Water*

**2 packages Cherry Kool Aid**

**2 Packages Orange Kool Aid**

Mix and add water, pre-sweetened or add the sugar.

*Hot JELL-O*

Mix 1-2 Tbl. JELL-O in a cup of hot water for a different breakfast drink. Cheery, Lime, and Orange are good to try.. **Beware not to drink boiling water.**

*Maxwell's Chocolate Bar*

1 cup Hot chocolate and add 1 Snickers bar, Mix, Melt, and drink or spoon.

*Cowboy Coffee*

**1 cup water for each cup of coffee**

**1 tablespoon ground coffee for each cup.**

In a 2 quart pot place the water and coffee. Cover and bring to a near boil. Remove from heat and set for 5 minutes. If grounds have not settled then add a splash of cold water. The grounds should sink to the bottom. If not then strain with mustach. Test by offering to Scoutmaster.

## Special Cooking

Special cooking refers to cooking using spits, paper bags, food in its own container, and other novelty type cooking. I will defer to selected readings.

Dutch Oven Cooking, John G. Ragsdale

\* Camper's Guide to Outdoor Cooking, John G. Ragsdale,

\* Outdoor Skills Instruction, Cooking, BSA

\* Venture manuals Winter Camping, Backpacking, BSA

\* Woods Wisdom, BSA

Brown, Tom, 1985, Tom Brown's Guide to Wild Edible and Medicinal Plants,

Gibbons, Euell, 1970, Stalking the Wild Asparagus

Thomas, Dian, 1994, Roughing It Easy; 2nd edition.,

*Twist on a Stick*

*old time favorite*

**1 cup Bisquick mix**

**water**

**cinnamon sugar**

Mix the Bisquick with enough water to form a dough. Roll into a long piece and wrap or twist around a clean green stick (not dried out). Sprinkle cinnamon sugar on twist. Place or hold stick over a fire and bake on all sides. Bake until golden brown. Break off a piece to check if inside is done. EAT

*Crescent Rolls on a Stick*

*Modern time favorite*

**tube of refrigerated Crescent rolls**

**Butter or margarine**

**Jam, jelly or honey**

Using a thick green stick about 1 inch in diameter, wrap the dough for a crescent roll spiral fashion around the tip of the stick. Leave space with the spiral for the heat to reach all of the dough. Press the ends of the dough to the stick to stick to the stick..... Hold the stick over coals for 15-20 min., turning frequently as you salivate. When golden brown, slip the roll of the stick and spread with butter, jam, jelly, or honey. plan for 1-3 rolls per scout.

**Just Deserts**

*Cheap Pie*

*Dennis A. Schmitt*

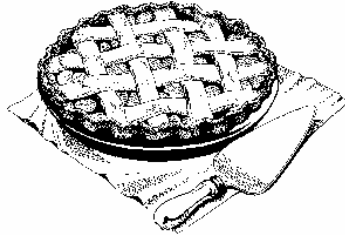

**2 slices bread      margarine      cinnamon sugar,  
jam or fruit pie filling      heavy foil**

Butter two slices of bread, place buttered side down on foil. spoon on fruit filling and cinnamon sugar. Place on top the other slice of buttered bread and pinch the edges together. Seal in foil and lay on the coals for 10 minutes or so, turn over for another 5 minutes.

*Baked Bananas*

*Ed Bailey*

**FOIL**

Do not peel the bananas, but cut off the end tips to keep from breaking the foil. Slit the skin on the inside curve and fill with raisins and cinnamon sugar, chocolate or butterscotch chips, M&M's , brown sugar, chocolate bar squares, wheat germ, mini-marshmallows. Place on heavy foil and wrap tightly. Heat over coals 10-15 minutes.

*Trail Cobbler*

*John G. Ragsdale*

**Dutch Oven**

**2 cups biscuit mix      1 cup margarine  
2 cups sugar      1 can fruit, drained      2 cups milk or water**

Mix the biscuit mix, sugar, milk, and margarine. Add fruit and stir. Bake in covered oven about 1 hour. serves 8.

*Apple Rings*

*Ed Bailey*

**FOIL**

For each serving, place **3-4 thick apple slices** in **heavy double foil**. Sprinkle with **brown sugar** and **grated orange peel**. Dot with margarine and seal. Cook over low coals 10-15 minutes.

*Foiled Again Apples.*

*Ed Bailey*

**FOIL**

Place a peeled and cored **apple** on a double square of **heavy foil**. Fill center with 1 T crushed **pineapple** and **raisins**. Sprinkle generously with **cinnamon sugar**. Fold foil around each apple and seal tightly. Place in glowing coals and bake 20-40 minutes depending on size. You can also try cinnamon candies for filling.

*Fruit Compost*

*I. B. Wisenheimer*

**1 cup dried fruit bits      1/2 cup sugar**

**1 teaspoon cinnamon**                      **graham cracker**

Rehydrate the fruit in enough boiling water to cover the fruit. Let simmer with the sugar and cinnamon till fruit is soft and the liquid is thick. Don't let the sugar burn. Top with graham cracker crumbs.

*Dutch Oven cake*

**1 box cake mix (your choice)**                      **2 cans fruit pie filling**  
**margarine**    **eggs if needed for cake**

Empty the cake mix into a Large zip-lock type bag, add water and eggs according to box directions. Close the bag and mix by needing the bag.  
 Line the Dutch oven with heavy foil, (saves on clean-up). Empty the 2 cans of fruit pie filling into the lined Dutch oven, pour the cake mix over the top. Don't stir. Cover and place on coals, add 5-10 hot coals on top. Bake 30-45 minutes. Check with tooth pick or cleaned green stick.  
 combinations:

- Chocolate cake and cherry pie filling
- Yellow cake and peach pie filling with maraschino cherries (no steams)
- White cake and apple pie filling with cinnamon

*Choco-Chip Pie*

**1 graham cracker crust pie shell**                      **1 package instant chocolate pudding and pie filling**  
**Cool Whip instant Mix**                                      **1/2 cup chocolate chips (or pick out from your GORP)**  
**dried milk powder.**

Mix the pudding mix, water, and milk. Let set for a few minutes and then fold in the chips. Pour into the crust. Whip up the Cool Whip mix and top the pie. Sprinkle a few chips on top. Great for that surprise birthday party at camp. **Serves 6**



*SomeMore's*

**Graham crackers**  
**Hershey's chocolate bars**

*Girl Scouts*

**marshmallows,**  
**and one campfire.**

Place large marshmallow (not the mini's) on a long peeled green stick and heat over campfire until gooey. Prepare the graham cracker by breaking into two squares. Place a chocolate square and the hoey-gooey marshmallow between the graham crackers and allow the chocolate to melt. Eat and have *SomeMore*.

*TOXIC CHOCOLATE PUDDING CAKE* *B. Hale*

This is so rich, it is not recommended for people with heart conditions...

**Utensils:** 12" Dutch Oven

**Spoon**

**Aluminum Casserole Baking pan that will fit in Dutch Oven  
(spring form pan will work if it seals good)**

**Mixing bowl**

**small pan to heat hot water**

**CAKE:** 2 cups Bisquick  
1/2 cup cocoa (unsweetened)  
2 cups Eagle Brand condensed milk  
1/2 cup chocolate syrup  
2 teaspoons vanilla extract

**PUDDING:** 1 cup chocolate syrup  
1 cup very hot water  
left over Eagle Brand milk from 2 -14 oz cans

Cake: Mix together biscuit mix, cocoa, 2 cups Eagle Brand milk and vanilla. Pour evenly in baking pan.

pudding: mix left over Eagle Brand milk, 1 cup chocolate syrup and 1 cup almost boiling water. This looks real runny. Now, CAREFULLY pour this over the cake batter without disturbing it as much as possible. DO NOT STRIR.

Bake until center is set.

Don't put too much heat on bottom, no more than 5 or 6 coals. Dont bake too long, as pudding will get too thick. When done, pudding will be on the bottom.

*Skillet Pudding*

*Ed Bailey*

**1 can evaporated milk**  
**3/4 cup instant cocoa mix**

**1/4 cup sugar**                      **3/4 cup water**  
**10-12 Graham crackers, cookies...**

Put the first 4 ingredients in a skillet and bring to a boil, stirring constantly. Add 10-12 coarsely broken graham crackers; cover. Cook over low heat for about 10 minutes, stirring occasionally.

*Here Come the Fudge*

*Eagle Brand*

*Double Boiler*

**1 12 oz. package semi-sweet chocolate chips**

**1 teaspoon vanilla extract**

**1 cup peanut butter chips  
milk**

**1 14 oz can Eagle Brand Sweetened condensed**

In a double boiler or heavy saucepan over low heat, melt the chocolate chips, vanilla extract, and sweetened condensed milk. Stir frequently. Remove from heat and add peanut butter chips. Stir to distribute, not to melt. Spread evenly into foil lined 8 inch square pan and chill in ice box for 2 hours or until firm. Turn over on cutting board and peel off foil. then cut into squares and protect from temptation.

*Termite Pie*

*Ed Bailey*

**1 box cake mix**

**2 quart zip lock bag**

**1 cup raisins**

**2 T. vegetable oil**

Need a sweet item for breakfast or night time snack? Mix a cake mix in a zip lock bag following directions on box, BUT use only 1/2 the suggested water. Add 1 cup of raisins (termites). Oil a small skillet or mess kit; pour in 1 cup of cake mix for a mess kit , 2 cups for a small skillet; cover pan; fry slowly, very slowly; flipping the pie when the top of the pie starts to set (dry out); cook a few more minutes and then count the termites as you eat.

*Instant Pie*

*Dennis A. Schmitt*

**1 box instant pudding mix,  
graham crackers.**

**1/4 cup instant milk**

Mix the pudding and dried milk with the right amount of cold water and beat with a whisk until thick. Pour into cups. Top with crushed graham crackers. **Serves 3-4.**

*Rice Krispies Treats*

*Kellogg's*

**6 cups Rice Krispies cereal  
vegetable cooking spray**

**1 10 oz package marshmallows  
1/4 cup margarine**

Melt margarine in a large saucepan over low heat. Add marshmallows and stir until completely melted. Remove from heat. Add Rice Krispies and stir until well coated. Using spatula or waxed paper, press mixture into 13 x 9 x 2 inch pan coated with cooking spray. Cut into squares when cool. **yields ~24 treats.**

*Add one or two below for variety*

**1/4 cup peanut butter**

**1/3 cup mini chocolate chips**

**1/3 cup caramel ice cream topping**

**1/2 cup sunflower seeds,**

*Pistachio Pudding*

*Jell-O*

**1 box instant Pistachio pudding      2 cups cold water      3 tbs. powdered milk**

Mix milk with water, add pudding and whip with a whisk for 2-3 minutes. Let set and serve.

*Joy's Joy*

*Joy Schmitt*

**1/2 cup sugar                                      3/4 cup light Karo Syrup      waxed paper  
1 cup Peanut Butter                          6 cups Corn Flakes                      shortening**

Melt the sugar and Karo Syrup in a sauce pan over low heat, add the Peanut butter. In a Large lightly greased bowl, pour the sauce over the 6 cups of Corn Flakes and fold in. Form or scoop into balls and cool on waxed paper.      *Variety: add 1/4 cup miniature chocolate chips.*

*Chocolate Tortillas*

**2 flour tortillas                                      chocolate bar or chips  
mini Marshmallows                              vegetable. oil**

Heat skillet with oil, Add tortilla. Add chocolate chips or pieces of bar and the marshmallows. Cover with second tortilla and flip. Cover until chocolate melts.

*Rice Krispies GORP Bars*

*Dennis Schmitt*

**6 cups Rice Krispies cereal                      vegetable cooking spray  
Peanuts    Raisins,  
M&M's    1/2 cup sugar  
3/4 cup light Karo Syrup                          1 cup Peanut Butter**

Melt the sugar and Karo Syrup in a sauce pan over low heat, add the Peanut butter. In a Large lightly greased bowl, pour the sauce over the 6 cups of Rice Krispies and fold in. Add 1/4 cup peanuts 1/4 cup M&M's. 1/4 cup raisins, and stir until well coated. Using spatula or waxed paper, press mixture into 13 x 9 x 2 inch pan coated with cooking spray. Cut into squares when cool. **yields ~24 treats.**

*Crunchy Granola Bar*

*Dian Thomas*

**1/2 cup crunchy peanut butter**

**2 T. honey**

**1 tsp. lemon juice**

Stir together and warm in large double boiler

**1 1/4 cups granola with dates**

add to mixture. press into a lightly greased 8x8 inch pan. cut into squares after drying until firm in dryer or low oven (120 F) with door open.

*Mock Coconut Angel Cake*

**6 thick (3/4- to 1-inch) slices bread**

**14 ounces sweetened condensed milk**

**(make your own with equal portions milk, powdered milk, and powdered sugar)**

**1 cup shredded coconut**

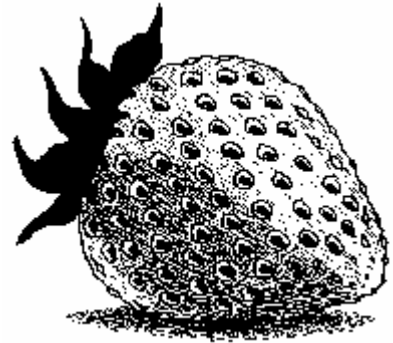

Cut bread slices into fourths. Dip the squares in the milk, then roll in the shredded coconut. Pierce the prepared square with a two-pronged fork and toast over the fire coals until lightly browned. Reverse position of the bread to brown both sides. Be careful, as this burns easily.

Yield: 24 squares

*Maple Pecan Oatmeal Bars*

**3/4 cup (1 1/2 sticks) butter or margarine (not diet or light)**

**2 1/4 cups quick or old-fashioned uncooked oats**

**1 1/2 cups firmly packed brown sugar**

**2 cups all-purpose flour**

**3/4 cup shredded coconut (optional)**

**1/4 teaspoon salt (optional)**

**1/3 cup maple-flavored pancake syrup**

**1 egg, lightly beaten**

**1 teaspoon vanilla Topping (recipe follows)**

**1 teaspoon baking soda**

Heat oven to 350 degrees. Lightly spray a 13-by-9-by-2-inch baking pan with vegetable oil cooking spray. Melt butter; set aside to cool. Combine oats, flour, brown sugar, coconut, soda and salt in large bowl; mix well. Combine melted butter, syrup, egg and vanilla in small bowl; mix well. Add to oat mixture; mix well (dough will be stiff). Press dough evenly onto bottom of pan. Add Topping as described below.

*Topping*

**1 1/2 cups chopped pecans (about 6 ounces)**

**1/4 cup firmly packed brown sugar**

**1/3 cup maple-flavored pancake syrup**

Combine pecans and sugar in small bowl. Sprinkle evenly over dough; press down lightly. Drizzle syrup evenly over pecans. Bake 35 to 38 minutes or until edges are set but middle is soft. Do not overbake. Cool completely in pan on wire rack. Cut into bars. Store tightly covered.

Makes 32 bars, each: 190 calories, 8 grams fat (70 calories from fat), 27 grams carbohydrates, 2 grams protein, 20 milligrams cholesterol, 85 milligrams sodium.

*Chocolate Eclair Dessert*

Mary Louise Giamfortone

- 2 (4-serving-size) packages French vanilla instant pudding** **3 cups milk**
- 1 teaspoon almond extract**
- 1 (8-ounce) tub frozen nondairy whipped topping, thawed**
- 1 (1-pound) box graham crackers (will have extra)**
- Chocolate Icing (recipe follows)**
- Maraschino cherries, halved,**
- and chopped pecans for garnish (optional)**

Combine pudding mix, milk and extract in a large bowl. Blend in whipped topping. Butter the bottom and sides of a 13-by-9-by-2-inch cake pan and line bottom with whole graham crackers. Cover with half the pudding mixture. Layer whole graham crackers on top of pudding. Spread remaining pudding mixture on top of graham crackers. Arrange another layer of graham crackers on top of pudding. Cover with Chocolate Icing and refrigerate, covered, 24 hours. Garnish with cherries and pecans. Makes 12 generous servings.

*Chocolate Icing*

- 6 tablespoons unsweetened cocoa powder** **5 tablespoons butter, softened**
- 3 tablespoons each: light corn syrup and milk** **1 teaspoon vanilla extract**
- 1 1/2 cups sifted powdered sugar**

Mix cocoa powder, butter, corn syrup, milk, vanilla and powdered sugar in electric mixer until smooth; spread on top of graham crackers, sealing well to edges.

*Georgia Peach Cobbler*

- 8 peaches, sliced (about 6 cups)** **1 1/4 cups sugar, divided**
- 2 tablespoons lemon juice** **1/2 teaspoon almond or vanilla extract**
- 1 1/2 cups flour** **1 1/2 teaspoons baking powder**
- 2 large eggs, beaten** **8 tablespoons (1 stick) butter, melted**
- 1 tablespoon brown sugar** **1/2 teaspoon ground cinnamon**

Preheat oven to 350 degrees. In bowl, mix peaches, 1/2 cup sugar, lemon juice and almond extract. Transfer to a 2-quart baking dish. In a clean bowl, mix flour, remaining 3/4 cup sugar, baking powder, beaten eggs and melted butter until moist but still lumpy. Do not overmix. Spoon topping over peaches. Sprinkle brown sugar and cinnamon over all. Bake 35 to 40 minutes, until golden brown. Let cool on rack.

*Cinnamon-Raisin Bread Pudding* by Andrew Schloss

- 1 (16-ounce) loaf raisin-cinnamon-swirl bread, cut into 1-inch pieces**
- 6 cups milk, divided**
- 2 (4-serving-size) packages cook-and-serve vanilla pudding.**

Preheat oven to 350 degrees. Toss bread pieces with 2 cups milk in a 13-by-9-by-2-inch baking dish. Let stand 10 minutes.

In a separate bowl, mix remaining milk with the pudding mix until smooth. Pour pudding mixture over soaked bread and toss lightly. Bake 1 hour, or until browned and set almost all the way into the middle. Remove from oven and cool on a wire rack at least 15 minutes before serving. Serve warm or chilled. Makes 12 servings.

Page for your own favorite recipes.....

*Your favorite.....*

